



# User Manual

## TDcH & TDmH – Compact Headend & Mini Headend

Article		Article no.	Article		Article no.
TDcH 16S-I-Q	Compact Headend	492780	TDmH IP	Mini Headend	492770
TDcH 16S-I		492781	TDmH 8S		492772
TDcH 22STC-I		492782	TDmH 8S-I		492773
TDcH 16S-Q		492790	TDmH 14STC-I		492774
TDcH 16S		492791			

Version	V1.8	Date	2024-05-23	EN
---------	------	------	------------	----



- 1 SAFETY REGULATIONS AND NOTES..... 5**
- 2 REVISION HISTORY ..... 7**
- 3 TDCH COMPACT HEADEND & TDMH MINI HEADEND ..... 7**
  - 3.1 INTRODUCTION..... 7
  - 3.2 DESCRIPTION ..... 9
    - 3.2.1 TDcH variants ..... 9
    - 3.2.2 TDmH variants..... 10
    - 3.2.3 Common Features ..... 11
    - 3.2.4 Upgrade Features (license based) ..... 12
    - 3.2.5 Block diagram ..... 12
  - 3.3 PACKING CONTENTS ..... 12
  - 3.4 TECHNICAL DATA ..... 13
- 4 MOUNTING THE UNIT..... 16**
  - 4.1 INSTALLING THE DEVICE ..... 16
    - 4.1.1 Example of mounting options for the TDcH ..... 16
    - 4.1.2 Example of mounting options for the TDmH ..... 17
    - 4.1.3 Potential equalisation ..... 17
  - 4.2 DEVICE OVERVIEW ..... 17
  - 4.3 CONNECTING THE DEVICE ..... 18
- 5 INSTALLATION & EASY SETUP ..... 19**
  - 5.1 INSTALLATION ..... 19
    - 5.1.1 Static IP address ..... 19
    - 5.1.2 Physical connection to headend ..... 19
    - 5.1.3 Starting service tool ..... 19
    - 5.1.4 System status LED ..... 20
    - 5.1.5 Input LEDs ..... 20
    - 5.1.6 Output LED ..... 20
    - 5.1.7 Reset button ..... 21
  - 5.2 TDCH & TDMH WEB INTERFACE (GUI) ..... 22
    - 5.2.1 Error indication..... 23
    - 5.2.2 Save configuration ..... 23
    - 5.2.3 Admin options ..... 23
    - 5.2.4 Dashboard ..... 23
    - 5.2.5 Channel Status Details ..... 25
    - 5.2.6 Report Issue..... 25
    - 5.2.7 Admin menu ..... 26
  - 5.3 SETTINGS ..... 28
    - 5.3.1 Ethernet Port 1 (Management Port) ..... 28
    - 5.3.2 System reset ..... 29
    - 5.3.3 Ethernet port 2 ..... 29
    - 5.3.4 SFP interface..... 29
    - 5.3.5 VLAN at SFP interface..... 30
    - 5.3.6 Device Name ..... 30
    - 5.3.7 Output Modulation ..... 30
    - 5.3.8 Channel Plan ..... 31
    - 5.3.9 Language..... 32
    - 5.3.10 Timezone ..... 33
    - 5.3.11 Time / internal clock..... 33
    - 5.3.12 Country..... 33



- 5.3.13 *Device Description* ..... 33
- 5.3.14 *Installer* ..... 34
- 5.3.15 *Installer Email and Phone*..... 34
- 5.3.16 *SNMP*..... 34
- 5.3.17 *Change Password* ..... 34
- 5.4 INPUT CONNECTIONS ..... 35
  - 5.4.1 *DVB-T2/C input*..... 35
  - 5.4.2 *DVB-S2X inputs*..... 35
  - 5.4.3 *Connections in GUI* ..... 35
  - 5.4.4 *Description/Alias* ..... 36
  - 5.4.5 *Single Satellite Reception* ..... 36
  - 5.4.6 *Multiple satellite reception* ..... 38
- 5.5 RF INPUTS ..... 40
  - 5.5.1 *Terrestrial and Cable tuner setup*..... 41
  - 5.5.2 *Satellite tuner setup* ..... 45
  - 5.5.3 *Service List*..... 50
- 5.6 IP INPUT ..... 51
  - 5.6.1 *Physical connectivity* ..... 51
  - 5.6.2 *IP-in licenses*..... 51
  - 5.6.3 *Requirements* ..... 52
  - 5.6.4 *Configuration in GUI*..... 53
- 5.7 CAM ..... 55
  - 5.7.1 *CAM / Smart card*..... 56
  - 5.7.2 *CAM configuration* ..... 56
  - 5.7.3 *Common interface*..... 59
  - 5.7.4 *Reset CAM*..... 59
- 5.8 RF OUTPUTS..... 60
  - 5.8.1 *QAM Modulation* ..... 62
  - 5.8.2 *COFDM Modulation* ..... 64
  - 5.8.3 *TSID and SID Management – RF Output* ..... 65
  - 5.8.4 *PID Management – RF Output* ..... 66
  - 5.8.5 *Multiple services – RF Output*..... 67
  - 5.8.6 *Rename services – RF Output*..... 67
  - 5.8.7 *Configure service type – RF Output*..... 67
- 5.9 IP OUTPUT ..... 68
- 5.10 LICENSE ..... 68
- 5.11 REQUIREMENTS..... 68
- 5.12 HARDWARE ..... 68
- 5.13 IPTV OUT CONFIGURATION IN GUI ..... 69
  - 5.13.1 *TSID and SID Management – IP Output* ..... 71
  - 5.13.2 *Rename Service – IP Output*..... 71
  - 5.13.3 *Configure service type – IP Output*..... 71
  - 5.13.4 *PID Management – IP Output* ..... 72
  - 5.13.5 *Multiple services – IP Output* ..... 72
- 5.14 LCN PAGE ..... 73
  - 5.14.1 *Network Settings*..... 73
  - 5.14.2 *Service Discovery*..... 76
  - 5.14.3 *EPG*..... 78
  - 5.14.4 *LCN*..... 78
- 5.15 OVERVIEW ..... 79
  - 5.15.1 *Export to Excel*..... 80
- 5.16 DIRECT ACCESS VIA URL..... 81



5.17 DIRECT FILE DOWNLOAD VIA URL ..... 82

6 SUPPORT ..... 83

7 TERMS AND ABBREVIATIONS ..... 84

## 1 Safety regulations and notes

### ATTENTION

- Failure to comply with the specified precautionary measures may cause serious injury to persons or damage to property.
- The assembly, installation, additional electrical wiring, servicing installation and commissioning may only be performed by suitably qualified persons, technicians, or installers in compliance with safety regulations.
- Damage due to improper installation and commissioning, defective connectors on cables or any other incorrect handling will void the warranty.

### CAUTION

- The device meets the EU directives **2011/65/EU, 2014/30/EU and 2014/35/EU**.
- The safety requirements are according to the standards EN 62368-1 resp. EN 60728-11 and must be observed, especially concerning equipotential bonding and earthing.
- Observe the relevant country-specific standards, regulations and guidelines on the installation and operation of antenna systems.
- Before starting installation or service work disconnect the receiving system from mains.
- Installation or service work should NEVER be undertaken during electrical / thunderstorms.
- Avoid short circuits!
- To ensure electromagnetic compatibility, make sure all connectors are tightly mounted, and that cables and connectors are of the right quality / screening.
- Prior to linking the T/C input port with a terrestrial antenna, it's imperative to ensure that a RED-compliant filter or amplifier is installed between the antenna and the headend to adhere to the directive.
- Take action to prevent static discharge when working on the device!
- Due to the risk of fires caused by lightning strikes, we recommend that all mechanical parts (e.g. distributor, equipotential bonding rail, etc.) be mounted on a non-combustible base. Wood panelling, wooden beams, plastic covered panels and plastic panels are all examples of combustible bases.



#### Back up battery:

The unit includes a preinstalled Lithium battery (CR2032) as backup power source for the clock.

Type: Panasonic BR-2032/BN, Battery, Coin Cell, Single Cell, 3 V, 2032, 225 mAh

Do not attempt to replace the non-rechargeable coin-cell battery. Replacement of the battery must only be done by a special trained technician.

**There is a danger of an explosion if the coin-cell battery is incorrectly placed. The lithium battery contains lithium and can explode if it is not properly handled or disposed of. Replace only with a battery of the same type. To avoid possible injury or death, do not: (1) Throw or immerse into water, (2) allow it to heat more than 100°C (212°F) or (3) attempt to repair or disassemble it. Dispose of it as required by local ordinance or regulations and your company's safety standards.**



### To prevent fire, short circuit or shock hazard

- Do not expose the unit to rain or moisture.
- Install the unit in a dry location without infiltration or condensation of water. In case of the formation of condensation wait until the system is completely dried.
- Do not expose it to dripping or splashing.
- If any liquid should accidentally fall into the cabinet, disconnect the power plug.
- Install the head-end station where it is protected from direct exposure to sunlight.
- Install the head-end station not within the immediate vicinity of heat sources.
- Do not install the head end in cabinets or recesses which are not ventilated.
- Do not place any vessels containing liquids on the head-end station.
- Do not place anything on the head-end station which could initiate fires.



### To avoid any risk of overheating

- Install the unit in a well aired location and keep a minimum distance around the apparatus for sufficient ventilation.
- Do not place anything on the unit that might cover the ventilation holes.
- Do not install the product in a dusty place.
- Use the apparatus only in moderate climates (not in tropical climates)
- Respect the minimum and maximum temperature specifications.
- Ensure that the headend station is adequately ventilated.



### To avoid any risk of electrical shocks

- Controller must be correctly grounded according to applicable national regulations.
- For a complete disconnection from the mains, the mains plug must be pulled out of the mains socket. Ensure that the mains plug can be pulled out without difficulties.
- Pull out power plug when making connections of cables.
- To avoid electrical shock, do not open the housing.



### To avoid interferences with LTE services in Europe

- Do not select a channel higher than UHF 48 in countries with LTE II / 700 operation.
- Do not select a channel higher than UHF 60 in countries with LTE I / 800 operation.
- Use coaxial cables with screening effectiveness of >85dB (Class A) at least or >95dB (Class A+)



### WEEE disposal



Electronic devices should never be disposed of in the household rubbish. In accordance with directive 2011/65/EU of the European Parliament and the European Council from June 8, 2011 which addresses old electronic and electrical devices, such devices must be disposed of at a designated collection facility. At the end of its service life, please take your device to one of these public collection facilities for proper disposal.

## 2 Revision history

Revision	Date	Changes
1.0		TDcH Compact Headend user manual - First release
1.1		Management Port description added
1.2		New Compact Headend Version TDcH 16S-I and TDcH 22STC-I added
1.3		SCR (Satellite Channel Router) description added
1.4		IP-out functionality added
1.5		IP-in functionality added
1.6	2023-12-07	<p>Besides updating screen dumps and general updating, feature description added for</p> <ul style="list-style-type: none"> <li>• VSecure scrambling</li> <li>• Alternative EIT (EIT Barker) for all RF inputs (DVB-S2/C/T2).</li> <li>• Alias for naming input connections.</li> <li>• Rename a service at the output page</li> <li>• Payload indication at CAM page added</li> <li>• 8 days EIT option added to existing 4 days EIT option for schedule EIT.</li> </ul> <p>Document based on features in SW version 2.6.0.</p>
1.7	2024-04-17	Added TDmH variants 492770, 492772, 492773, and 492774.
1.8	2024-05-23	<p>Added VLAN and Service Overview via URL features.</p> <p>Added description for time.</p>

## 3 TDcH Compact Headend & TDmH Mini Headend

### 3.1 Introduction

TRIAX offers two series of headend variants.

The TDcH Compact Headend was the first series introduced in the market. This highly reliable headend series offers many stable features and is flexible in variants and licenses.

Years later, the TDmH Mini Headend was introduced as a miniature series based on the highly reliable TDcH. This headend series was introduced to offer even more variants for different applications.

This user manual is for both headend series. Some of the features listed are only available in TDcH or in specific variants.



## 3.2 Description

TDcH and TDmH Headend supports DVB-S2X, DVB-T2, DVB-C and IP-in receiving and conversion to IPTV and/or QAM / COFDM modulation with the possibility to decrypt and/or scramble services centrally in the headend.

Built for wall- as well as 19" racks mounting and equipped with up to 4 DVB-S2X inputs, 1 DVB-T2/C input and 1 IP input, 16 DVB-S2X tuners, 6 DVB-T2/C tuners, 16 QAM or COFDM modulators and 8 CI slots.

The TDcH and TDmH Headends are optimized and engineered to meet specific TV distribution requirements in hospitality, multi-dwelling units and related sectors.

Our brand new, intuitive platform smoothly integrates easy installation, an intuitive and elegant graphical user interface, central decryption, remote access, and straightforward TV service updates with LCN.

### 3.2.1 TDcH variants

<b>TDcH 16S-Q</b> <b>[492790]</b>	4 x SAT IF inputs with integrated multiswitch 16 x DVB-S2 tuners 1 x IP (RJ45 or SFP LC duplex) 16 x QAM full band modulators
<b>TDcH 16S-I-Q</b> <b>[492780]</b>	4 x SAT IF inputs with integrated multiswitch 16 x DVB-S2X tuners 1 x IP (RJ45 or SFP LC duplex) 8 x CI interfaces 16 x QAM full band modulators
<b>TDcH 16S</b> <b>[492791]</b>	4 x SAT IF inputs with integrated multiswitch 16 x DVB-S2 tuners 1 x IP (RJ45 or SFP LC duplex) 16 x QAM or COFDM full band modulators
<b>TDcH 16S-I</b> <b>[492781]</b>	4 x SAT IF inputs with integrated multiswitch 16 x DVB-S2 tuners 1 x IP (RJ45 or SFP LC duplex) 8 x CI interfaces 16 x QAM or COFDM full band modulators
<b>TDcH 16S-I</b> <b>Pro:Idiom (LG) ready</b> <b>[492787]</b>	Identical to TDcH 16S-I [492781], but with the option for buying licence for Pro:Idiom (LG) scrambling
<b>TDcH 22STC-I</b> <b>[492782]</b>	4 x SAT IF inputs with integrated multiswitch 1 x Terr / Cable input with integrated splitter 16 x DVB-S2 tuners 6 x DVB-T/T2/C tuners 1 x IP (RJ45 or SFP LC duplex) 8 x CI interfaces 16 x QAM or COFDM full band modulators

**TDcH 22STC-I Pro:Idiom (LG) ready [492788]** Identical to TDcH 22STC-I [492782], but with the option for buying licence for Pro:Idiom (LG) scrambling

### 3.2.2 TDmH variants

**TDmH IP [492770]** 48 x IPTV inputs SPTS and MPTS UDP/RTP  
1 x IP (RJ45 or SFP LC duplex)  
8 x QAM or COFDM full band modulators

**TDmH 8S [492772]** 4 x SAT IF inputs with integrated multiswitch  
8 x DVB-S2X tuners  
1 x IP (RJ45 or SFP LC duplex)  
8 x QAM or COFDM full band modulators

**TDmH 8S-I [492773]** 4 x SAT IF inputs with integrated multiswitch  
8 x DVB-S2 tuners  
1 x IP (RJ45 or SFP LC duplex)  
4 x CI interfaces  
8 x QAM or COFDM full band modulators

**TDmH 8S-I Pro:Idiom (LG) ready [492775]** Identical to TDmH 8S-I [492773], but with the option for buying licence for Pro:Idiom (LG) scrambling

**TDmH 14STC-I [492774]** 4 x SAT IF inputs with integrated multiswitch  
1 x Terr / Cable input with integrated splitter  
8 x DVB-S2 tuners  
6 x DVB-T/T2/C tuners  
1 x IP (RJ45 or SFP LC duplex)  
4 x CI interfaces  
8 x QAM or COFDM full band modulators

**TDmH 14STC-I Pro:Idiom (LG) ready [492776]** Identical to TDmH 14STC-I [492774], but with the option for buying licence for Pro:Idiom (LG) scrambling

### 3.2.3 Common Features

#### 4 x SAT IF inputs

- Integrated multi switch
- SCR (Satellite Channel Router) support
- DiSEqC support
- LNB LOF configuration

#### 1 x Terr – Cable input (TDcH 22STC-I, TDmH 14STC-I)

- Integrated splitter

#### 1 x Connections

##### IP input

- SID and TSID management, PID management
- XSPF supported

##### RF input

#### 16/8 x DVB-S2 tuners (except TDmH IP)

#### 6 x DVB-T/T2/C tuners (TDcH 22STC-I, TDmH 14STC-I)

#### 8/4 x CI interfaces

- (all variants with “I” include in the name)

#### 16 x QAM full band modulators

- (TDcH 16S-Q, TDcH 16S-I-Q)

- Electronically adjustable output level
- Suitable for adjacent channels, option for disabling individual channels
- Adjustable Symbol rates and modulation

#### 16 x QAM or COFDM full band modulators

- (all variant except TDcH 16S-Q and TDcH16S-I-Q)

- Electronically adjustable output level
- Suitable for adjacent channels, option for disabling individual channels
- For QAM adjustable Symbol rates and modulation, and for COFDM adjustable modulation, FEC and Guard Interval

#### Service Multiplexing

- Service Multiplexing at each output transponder to optimize available bandwidth
- Service Multiplexing at the CA modules to reduce amount of needed CAM’s
- Service routable from any input to any output

#### SID, TSID and ONID management

- To handle conflicts during multiplexing
- To carry out changes if required
- To replace a service with another service without any need for re-tuning the TVsets.

#### HTML user interface via self-signed HTTPS

#### PID management

- To handle PID conflicts
- PID filtering, for example to reduce audio channels from a TV service
- Distribute the same TV service multiple times with different languages
- To replace a service with another service without any need to re-tune the TVsets

#### Service naming

- Distribute the same TV service multiple times with different language and different name
- Give the service an alternative name
- If a service has no original name, an optional service name can be configured
- If multiple services have the same original name, unique service names can optionally be configured.

#### EPG management

- EPG handling to manage the amount of EPG-data distributed in an output transponder

#### Transport Stream Processing

- Network Information Table (NIT) for complete head-end station
- LCN (Logical Channel Numbering)

#### Transparent Transport Stream routing

- A whole untouched transponder can be routed to CAM to ensure all metadata are intact and present for the CA module
- A whole untouched transponder can be routed to an output to ensure all metadata is present or just for debug

#### Payload measurement

- Realtime payload measurement at CI slot to monitor transport stream to CAM is fine and not overloaded with services
- Realtime payload measurement at RF output to monitor transport at output is fine and not overloaded with services
- Realtime payload measurement at CI slot, RF output and IP output to monitor if data exists at all

#### SNMP traps

- To remotely monitor changes
- Supported traps described in the MIB

### 3.2.4 Upgrade Features (license based)

#### IP-in

The IP-in functionality requires an activation license key.

Additional to common features, supported functionalities for IP-in:

- Receive up to 96 x UDP or RTP MPEG-TS multicast streams
- Specify source address and port to ensure correct source
- Licenses comes in
  - 4 x IP SPTS or MPTS inputs
  - 16 x IP SPTS or MPTS inputs
  - 48 x IP SPTS or MPTS inputs
  - 96 x IP SPTS or MPTS inputs

#### IP-out

The IP-out functionality requires an activation license key.

Additional to common features, supported functionalities for IP-out:

- Stream up to 100 UDP MPEG-TS multicast streams
- Supported Service Discovery protocols: M3U, M3Ue, M3Uepp, XSPF
- EPG for all IP out services in Samsungs XML format for SINC or REACH server
- EIT for current service inside the SPTS streamed via UDP/RTP multicast direct to the TV set

### 3.2.5 Block diagram

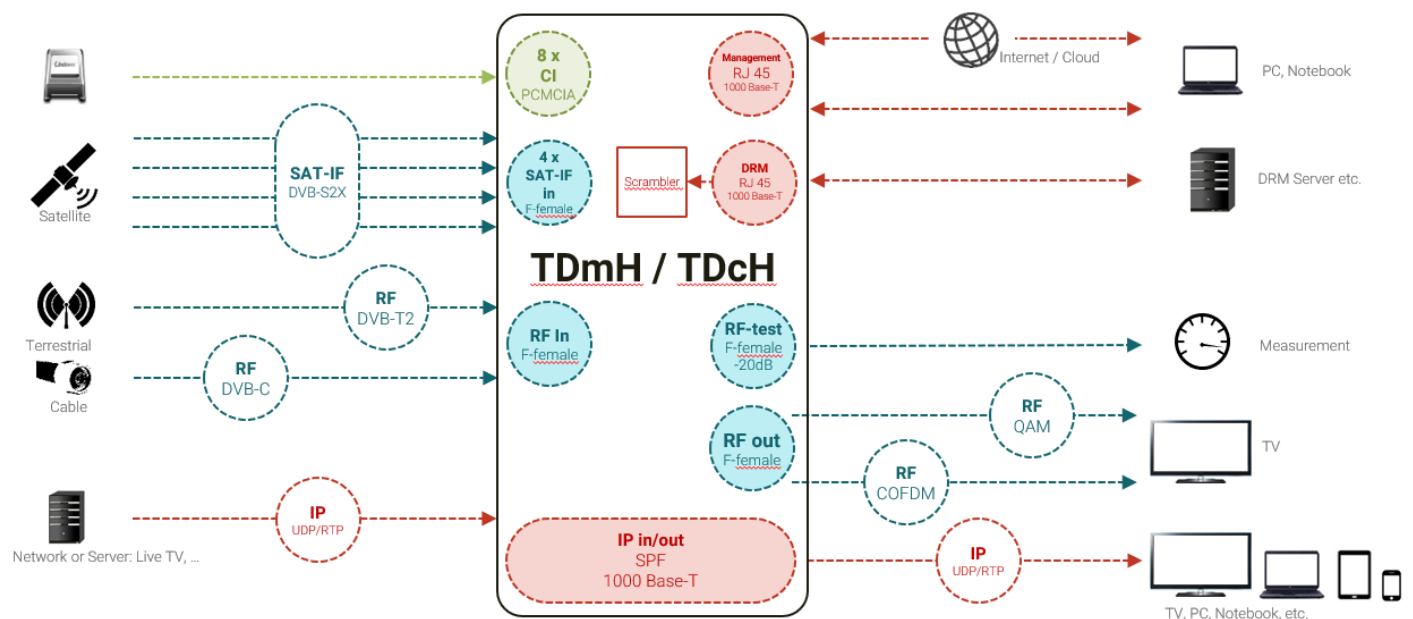

#### Note:

IP-in license-based function  
 IP-out license-based function

### 3.3 Packing contents

- 1 piece TDcH Compact headend or TDmH Mini headend
- 1 piece Mains cable
- 2 pieces Wall mounting brackets
- 4 pieces Screws

## 3.4 Technical data

Type	TDcH 16S-Q	TDcH 16S	TDcH 16S-I-Q	TDcH 16S-I	TDcH 22STC-I	TDmH IP	TDmH 8S	TDmH 8S-I	TDmH 14STC-I	
Art. number [Pro:Idiom (LG) Ready]	492790	492491	492780	492781 [492787]	492782 [492788]	492770	492772	492773 [492775]	492774 [492776]	
<b>Interfaces</b>										
Management Interface	1 x 1000 Base-T (RJ 45)									
SimulCrypt / DRM	1 x 1000 Base-T (RJ 45) not supported with current software release									
Ip-in and -out	1 x 1000 Base-T (SFP)									
CI slots	-	-	8 x PCMCIA (front access)			-	-	4 x PCMCIA (front access)		
USB	USB 2.0, Type A conn (Data transfer, additional storage,...) not supported current software release									
<b>DVB-S2X input</b>										
Satellite inputs	4 x F connectors, 75 Ω, 400 mA per input LNB power feed					-	4 x F connectors, 75 Ω, 400 mA per input LNB power feed			
Number of transponders	16					-	8			
Frequency range	950 – 2150 MHz					-	950– 2150 MHz			
Level range	44 – 90 dBμV					-	44 – 90 dBμV			
Return loss	> 10dB					-	> 10dB			
DVB-S modulation	QPSK; 8PSK, 16APSK, 32APSK (16APSK and 32APSK will be supported in later SW version)					-	QPSK; 8PSK, 16APSK, 32APSK (16APSK and 32APSK will be supported in later SW version)			
DVB-S modes	QPSK 1/2, 2/3, 3/4, 5/6, 7/8					-	1/2, 2/3, 3/4, 5/6, 7/8			
DVB-S2 modes	QPSK 1/2, 3/5, 2/3, 3/4, 4/5, 5/6, 8/9, 9/10 8PSK 3/5, 2/3, 3/4, 5/6, 8/9, 9/10 16APSK 2/3, 3/4, 4/5, 5/6, 8/9, 9/10 32APSK 3/4, 4/5, 5/6, 8/9, 9/10					-	QPSK 1/2, 3/5, 2/3, 3/4, 4/5, 5/6, 8/9, 9/10 8PSK 3/5, 2/3, 3/4, 5/6, 8/9, 9/10 16APSK 2/3, 3/4, 4/5, 5/6, 8/9, 9/10 32APSK 3/4, 4/5, 5/6, 8/9, 9/10			
Multistream	Supported					-	Supported			
Symbol rate DVB-S	QPSK: 1 – 45 MSymb/s					-	QPSK: 1 – 45 MSymb/s			
Symbol rate DVB-S2	QPSK: 4.5 – 45 MSymb/s 8PSK: 4.5 – 45 MSymb/s 16APSK: 4.5 – 39 MSymb/s 32APSK: 4.5 – 32 Msymb/s					-	QPSK: 4.5 – 45 MSymb/s 8PSK: 4.5 – 45 MSymb/s 16APSK: 4.5 – 39 MSymb/s 32APSK: 4.5 – 32 Msymb/s			
Max. data rate / tuner	83 Mbit/s					-	83 Mbit/s			
Input selection	DiSEqC 1.0 Control 13/18VDC, 22kHz and SCR via JESS (EN 50607:2015)					-	DiSEqC 1.0 Control 13/18VDC, 22kHz and SCR via JESS (EN 50607:2015)			
<b>DVB-T/T2/C input</b>										
Terrestrial / Cable input	-	-	-	-	1 x F connector, 75Ω	-	-	-	1 x F connector, 75Ω	
Tuners	-	-	-	-	6	-	-	-	6	
Supply voltage DVB-T antenna	-	-	-	-	Not supported	-	-	-	Not supported	
Input frequency range	-	-	-	-	47 – 862 MHz	-	-	-	47 – 862 MHz	
Channel bandwidth	-	-	-	-	7/8 MHz	-	-	-	7/8 MHz	
Level range	-	-	-	-	40 – 95 dBμV	-	-	-	40 – 95 dBμV	
Input noise	-	-	-	-	< 7 dB	-	-	-	< 7 dB	
Return loss	-	-	-	-	> 10 dB	-	-	-	> 10 dB	
<b>DVB-T</b>										
Demodulator type	-	-	-	-	COFDM	-	-	-	COFDM	
Modulation DVB-T	-	-	-	-	QPSK, 16QAM, 64QAM	-	-	-	QPSK, 16QAM, 64QAM	
Channel bandwidth	-	-	-	-	6/7/8 MHz	-	-	-	6/7/8 MHz	
FFT modes	-	-	-	-	2k, 8k	-	-	-	2k, 8k	
Code rate	-	-	-	-	1/2, 2/3, 3/4, 5/6, 7/8	-	-	-	1/2, 2/3, 3/4, 5/6, 7/8	
Guard interval	-	-	-	-	1/4, 1/8, 1/16, 1/32	-	-	-	1/4, 1/8, 1/16, 1/32	
<b>DVB-T2</b>										
Demodulator type	-	-	-	-	COFDM	-	-	-	COFDM	
Modulation DVB-T2	-	-	-	-	QPSK, 16QAM, 64QAM, 256QAM	-	-	-	QPSK, 16QAM, 64QAM, 256QAM	
Channel bandwidth	-	-	-	-	6/7/8 MHz	-	-	-	6/7/8 MHz	
FFT modes	-	-	-	-	1k, 2k, 4k, 8k, 16k, 32k	-	-	-	1k, 2k, 4k, 8k, 16k, 32k	
Code rate	-	-	-	-	1/2, 3/5, 2/3, 3/4, 4/5, 5/6	-	-	-	1/2, 3/5, 2/3, 3/4, 4/5, 5/6	



Type	TDcH 16S-Q	TDcH 16S	TDcH 16S-I-Q	TDcH 16S-I	TDcH 22STC-I	TDmH IP	TDmH 8S	TDmH 8S-I	TDmH 14STC-I	
Art. number [Pro:Idiom (LG) Ready]	492790	492491	492780	492781 [492787]	492782 [492788]	492770	492772	492773 [492775]	492774 [492776]	
Guard interval	-	-	-	-	1/4, 19/128, 1/8, 19/256, 1/16, 1/32, 1/128	-	-	-	1/4, 19/128, 1/8, 19/256, 1/16, 1/32, 1/128	
<b>DVB-C</b>										
Demodulator type	-	-	-	-	QAM	-	-	-	QAM	
Modulation	-	-	-	-	16QAM, 64QAM, 128QAM, 256QAM	-	-	-	16QAM, 64QAM, 128QAM, 256QAM	
Symbol rate	-	-	-	-	1 - 7,2 MS/s	-	-	-	1 - 7,2 MS/s	
<b>IP-Input</b>										
Number of IP input streams	4, 16 or 96 x SPTS/MPTS ( <i>license required</i> )					48 x SPTS/MPTS	4, 16 or 48 x SPTS/MPTS ( <i>license required</i> )			
Data interface	1 x 1000 Base-T SFP or Fibre SFP ; 1000BaseX (SerDes) mode									
Protocols	IEEE802.3 Ethernet SPTS Streaming (VBR) including PAT, SDT, PMT, CAT and EIT MPTS Streaming (VBR) including PAT, SDT, PMT, CAT and EIT Multicast UDP and RTP MPEG Transport Stream via IP Protocol									
IP packet format	MPEG									
IP-Bitrate	max. 950 Mbit/s at SFP interface for all SPTS streams									
<b>CI interfaces</b>										
Supported CAM vendors	-	-	Aston, Neotion, SMARDTV, SMiT			-	-	Aston, Neotion, SMARDTV, SMiT		
Supported modules and cards	-	-	Conax: Canal Digital (Nordic), Telewizja (Poland), T Home (Hungary) Cryptoworks: ORF (Austria), UPC Direct (Hungary) Irdeto: ORF (Austria) Nagravision: Canal Digital (NL), Canal + (France), Cyfra (Poland), Cyfrowy (Poland), Multicanal (Spain), UPC, NDS, Viasat (Nordic + Baltic) Viaccess: Fransat (France), Eurosport (Poland)			-	-	Conax: Canal Digital (Nordic), Telewizja (Poland), T Home (Hungary) Cryptoworks: ORF (Austria), UPC Direct (Hungary) Irdeto: ORF (Austria) Nagravision: Canal Digital (NL), Canal + (France), Cyfra (Poland), Cyfrowy (Poland), Multicanal (Spain), UPC, NDS, Viasat (Nordic + Baltic) Viaccess: Fransat (France), Eurosport (Poland)		
Bitrate	-	-	Configurable: 50, 72, 96Mbps			-	-	Configurable: 50, 72, 96Mbps		
PID and service limit	-	-	PID and service limit is given by the CAM			-	-	PID and service limit is given by the CAM		
Supply voltage	-	-	5V			-	-	5V		
<b>RF output</b>										
RF out	1 x F connector									
HF measuring output	1 x F connector, -20 dB									
Frequency range	306 – 862 MHz									
Channels	S 21 – C 69									
Channel settings	16 channels in a row, single channels can be switched off					8 channels in a row, single channels can be switched off				
Return loss	> 10 dB									
Output impedance	75 Ω									
<b>QAM modulation</b>										
Output level range	85 – 95 dBμV									
Modulation scheme	QAM 16, 32, 64, 128, 256									
Dynamic phase error	< 0.3									
MER	> 43 dB									
Symbol rate	3.5 – 7.2 MS/s									
<b>COFDM modulation</b>										
Output level range	-	83 – 93 dBμV	-	-	-	-	83 – 93 dBμV	-	-	
Carrier to spurious ratio:	-	> 60 dB	-	-	-	-	> 60 dB	-	-	
Modulation scheme:	-	QPSK, 16 QAM, 64 QAM	-	-	-	-	QPSK, 16 QAM, 64 QAM	-	-	
MER	-	>=40dB	-	-	-	-	>=40dB	-	-	
Output mode:	-	2k	-	-	-	-	2k	-	-	
Guard intervals:	-	1/4, 1/8, 1/16, 1/32	-	-	-	-	1/4, 1/8, 1/16, 1/32	-	-	
<b>IPTV Output</b>										
Number of IP output streams	100 x SPTS ( <i>license required</i> )					48 x SPTS ( <i>license required</i> )				
Data interface	1 x 1000 Base-T SFP or Fibre SFP ; 1000BaseX (SerDes) mode									
Protocols	IEEE802.3 Ethernet SPTS Streaming (VBR) including PAT, SDT, PMT, CAT and EIT									

**TDcH & TDmH - Compact and Mini Headend**

Type	TDcH 16S-Q	TDcH 16S	TDcH 16S-I-Q	TDcH 16S-I	TDcH 22STC-I	TDmH IP	TDmH 8S	TDmH 8S-I	TDmH 14STC-I
Art. number [Pro:Idiom (LG) Ready]	492790	492491	492780	492781 [492787]	492782 [492788]	492770	492772	492773 [492775]	492774 [492776]
	Multicast UDP and RTP MPEG Transport Stream via IP Protocol 7 TS packets pr. Ethernet packet								
IP packet format	MPEG								
IP-Bitrate	max. 950 Mbit/s at SFP interface for all SPTS streams								
PID-Filtering and Remapping	Yes								
TTL	1-255 (default 16)								
EIT	Inside SPTS for current service								
XML EPG	EPG data in XML format as specified by Samsung Configurable language and Maturity Rating Country for XML EPG								
<b>Scrambling</b>									
VSecure (Philips) [Philips TV + special CAM]	-	-	-	License required 48 x		-	-	License required 48 x	
Pro:Idiom (LG) [Special hardw. variants required]	-	-	-	License required 24 x		-	-	License required 24 x	
LYNK (Samsung)	-	-	-	License required (future) 48 x		-	-	License required (future) 48 x	
Simulcrypt (128bit AES)	-	-	-	License required (future) 48 x		-	-	License required (future) 48 x	
<b>Features</b>									
SNMP	SNMP traps (license required)								
Common NIT/SDT/EIT	Option via license					-	-	-	-
Stackable (common GUI plus feature to Common NIT/SDT/EIT)	Option via license					-	-	-	-
<b>General</b>									
Mains supply	100 - 264 VAC, 50/60 Hz								
Ground connection	Ground clamp								
Power consumption * Without CAM and LNB power	*typ. 35 W, max. 90 W	*typ. 32 W, max. 90 W	*typ. 39 W, max. 90 W	*typ. 36 W, max. 90 W	*typ. 46 W, max. 90 W	typ. 20W, max. 25W	typ. *30 W, max. 65 W	typ. *33 W max. 73 W	typ. *40 W, max. 80 W
Ambient temperature	-10°C to +50°C								
Dimensions in mm	(W x D x H) 434 x 220 x 90					(W x D x H) 434 x 168 x 45			
Weight	3.8 kg	3.8 kg	4.0 kg	4.1 kg	4.1 kg	2.6 kg	2.8 kg	3.0 kg	3.1 kg

## 4 Mounting the unit

### 4.1 Installing the device

The TDcH & TDmH can be mounted in a 19" rack or wall mounted in any direction needed.

Ensure that the unit is correctly grounded, according to applicable national regulations.

Ensure that min. 4 cm ventilation space is available on both sides of the equipment, so that the fans and ventilation holes are not covered!

#### 4.1.1 Example of mounting options for the TDcH

An example of mounting options for the TDcH similar option can also be applied to TDmH.

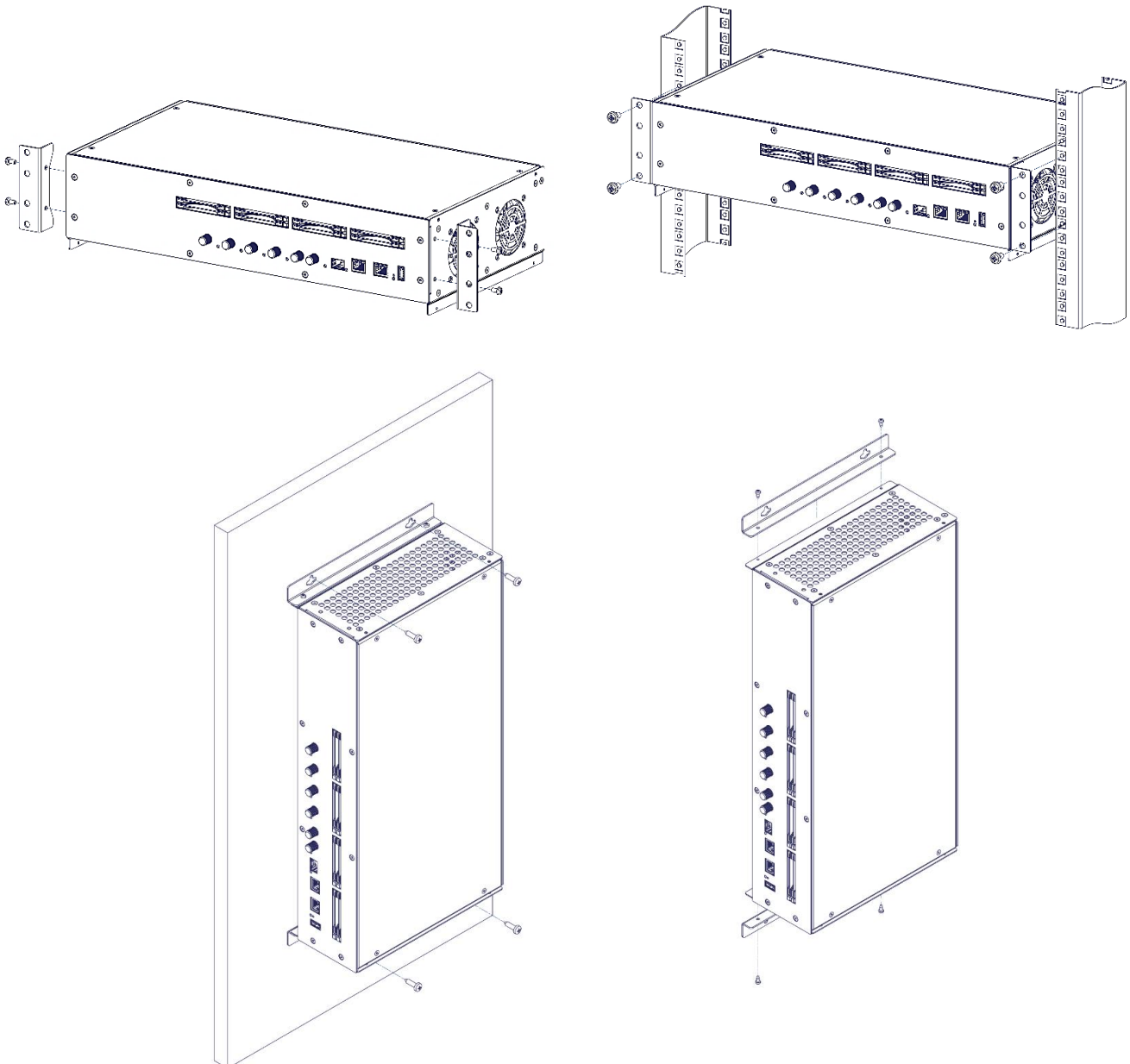



#### 4.1.2 Example of mounting options for the TDmH

The positioning of the TDmH brackets when installing the headend in either a rack or wall mount configuration. The 19" rack mounting is the default position of the brackets, but the installer can change to wall mount installation, by removing the 2\*4 screws and turn the brackets, and mount the 2\*4 screws again.

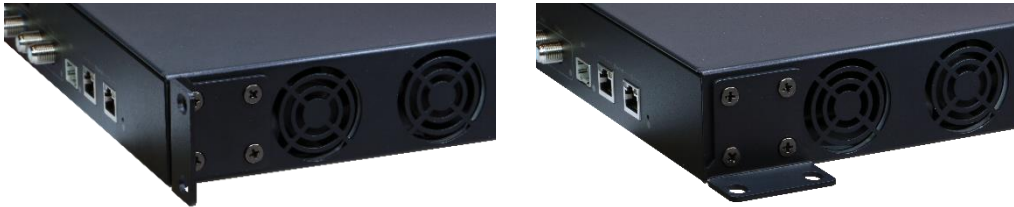

#### 4.1.3 Potential equalisation

Equalise the potential (PE) in accordance with IEC/EN/DIN EN 60728.

Connect the PE connection terminal to a PE rail (supplied by customer) using the PE wire (Cu 4 mm<sup>2</sup> - 9 mm<sup>2</sup>).



#### 4.2 Device overview



**Possible connections:**

- 1 F-conn for DVB-C/T/T2
- 4 F-conn for DVB-S/S2/S2X
- 1 F-conn for test (-20dB)
- 1 F-conn for TV-out (QAM or COFDM)
- 1 SFP for IP IN and IP OUT (UDP/RTP)
- 1 RJ45 for Internet/Cloud/Management
- 1 RJ45 for DRM server
- 4 or 8 PCMCIA for CI cards (4 TDmH, 8 TDcH)
- 1 USB for future use (TDcH only)

- COAX
- IP
- HDMI

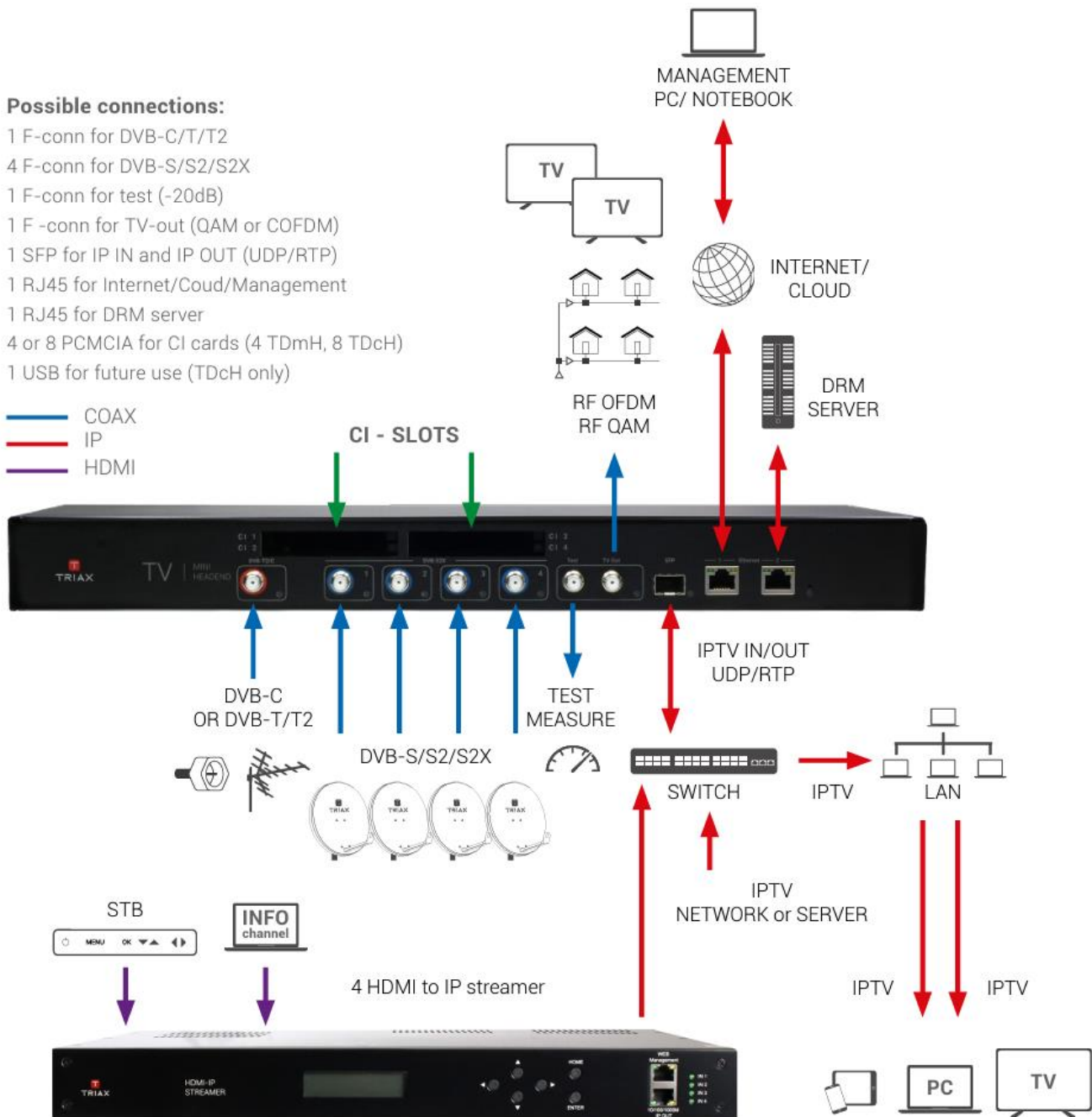

### 4.3 Connecting the device

- Connect the SAT IF inputs to the corresponding outputs of an LNB or multi switch. Make sure that all inputs have the same level and are in the required level range!
- Connect the Terr/Cable input to the corresponding output of a terrestrial or cable distribution. Make sure that the input level is in the required level range!
- Connect the included mains cable to the IEC connector.
- Connect the mains cable to a mains socket with protective conductor connection. Note the voltage specified on the device.
- This device has no power switch and starts immediately after connecting the operating voltage.
- Configure the device as described in the chapter “Installation & Easy Setup”
- Once the programming is finished, connect the RF output to the cable network.

## 5 Installation & Easy Setup

### 5.1 Installation

#### 5.1.1 Static IP address

A static address must be used on the computer you use to configure the headend. Refer to the computer's operating software documentation for assistance on using static IP addresses.

#### 5.1.2 Physical connection to headend

Connect a Cat5e shielded cable or better between the computer's network port and the management port on the headend.



**Note:**

Please use Ethernet port 1 to connect your PC to the headend

Ethernet port 2 is reserved for future use. Currently the management GUI can't be reached at this port. The port is configured to get the IP address via DHCP.

#### 5.1.3 Starting service tool

Open a web browser window.

Recommended browser:

- Google Chrome version 90.x.x.x
- Mozilla Firefox version 88.x.x
- Microsoft Edge 90.x.x.x

Enter **http://192.168.0.100** in the web address field. Press **Enter**.

Enter the password. Press the **Login** button.

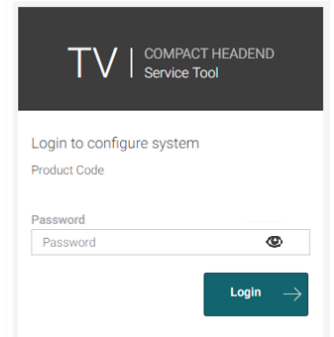

**Note:**

Password = **triax1234** when the service tool is opened on each headend for the first time. At the first login to the unit, the password must be changed to a unique password, as described in the section "Change password".

Up to 10 sessions can be opened and logged in to the same units user interface!

If the user does not log out, the session will be kept open.

When the 11<sup>th</sup> session is opened the first login session will be closed.



# TRIAX

## 5.1.4 System status LED

Input LED indications

Below the reset button there is a general system status LED. The following status LED indications are available:



- Off:** The system is turned off
- Flashing green:** The system is starting up
- Flashing orange (green+red):** Software update in progress
- Steady green:** System is up and running OK. No error seen within the last 24 hours. All demodulators using this input is OK (tuned/locked). CA modules are descrambling OK. No packages dropped at outputs.
- Steady red:** At least one error has occurred in the system within the last 24 hours. E.g. one or more demodulator(s) using this input indicate(s) ERROR (not locked/tuning lost), descrambling fails at one or more CA modules, or packages dropped at a least one output.

## 5.1.5 Input LEDs

Input LEDs indication



- Black (Off):** This input is not in use by any demodulator
- Amber (Green+Red):** One or more demodulator(s) using this input, indicates WARNING (bad signal (C/N to high, level to low, etc...))
- Red:** One or more demodulator(s) using this input, indicates ERROR (not locked)

## 5.1.6 Output LED

Output LED indications



- Green:** All outputs are OK
- Red:** One or more output(s) indicates ERROR (overload)

## TDcH & TDmH - Compact and Mini Headend

### 5.1.7 Reset button

The following Reset functions are available:



When the reset button is pressed (during startup) until the LED flashes green, then the system resets to factory defaults.

When the reset button is pressed (during startup) until the LED flashes red, then the system starts in recovery mode.



### 5.2 TDcH & TDmH web interface (GUI)

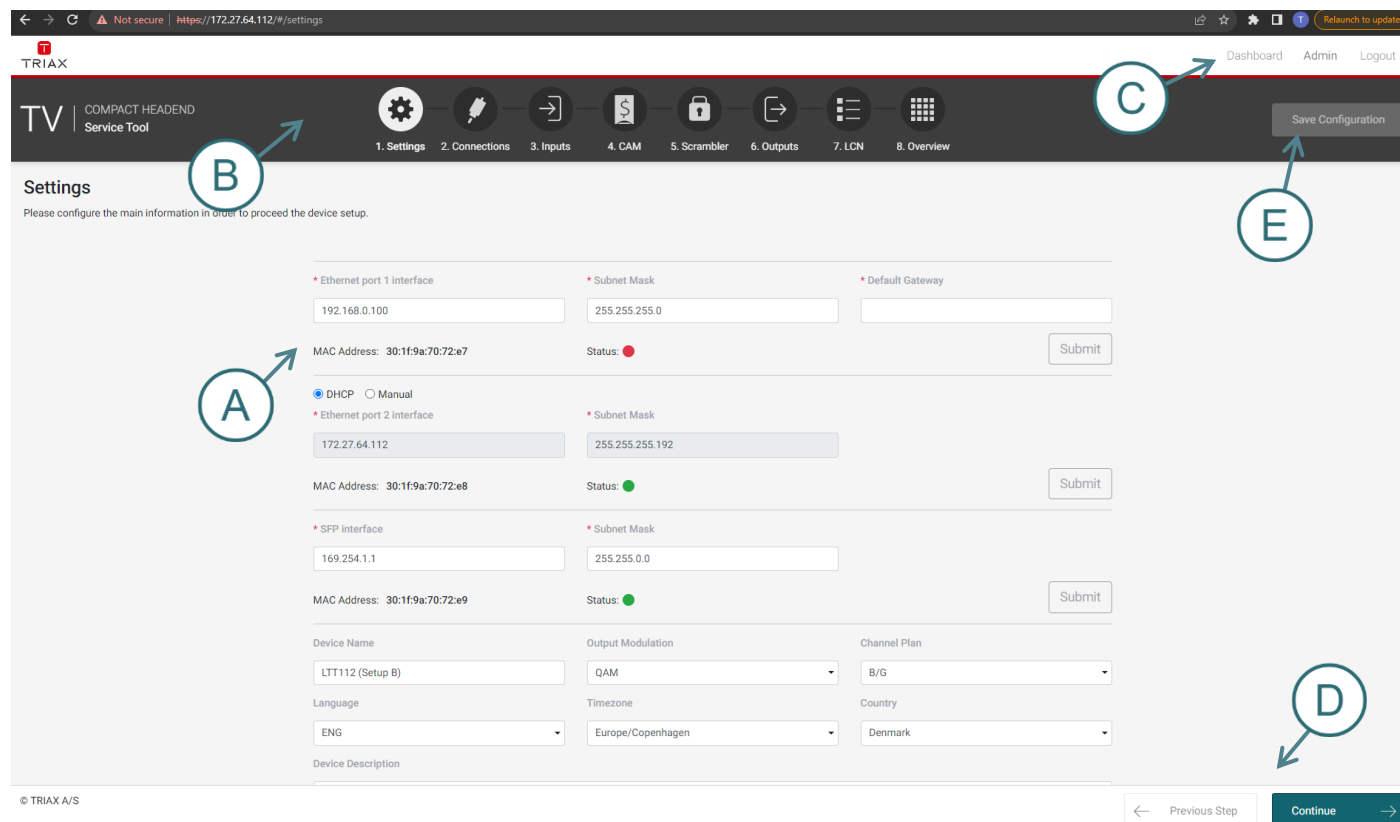

- A. Information window
- B. Navigation bar
- C. Administrator and Dashboard menu
- D. Installation wizard function to continue or go one step back
- E. Save Configuration

When logged in, you will be met by 8 panes:

- |                |   |
|----------------|---|
| 1. Settings    | basic settings of the system (TDcH & TDmH setup)                          |
| 2. Connections | assign input cables to available tuners                                   |
| 3. Inputs      | configure to desired provider and services                                |
| 4. CAM         | assign services to CAMs (only shown if the model supports it)             |
| 5. Scrambler   | assign services to scrambler (only shown if the model supports it)        |
| 6. Outputs     | assign services to outputs  |
| 7. LCN         | assign services to required LCN number and configure the network settings |
| 8. Overview    | see the complete assignment from inputs to outputs                        |

Less than 8 panes might be shown if the TDcH & TDmH model does not support the feature. E.g. CAM and Scrambler panes are not shown for TDcH & TDmH models without CI slots.

### 5.2.1 Error indication

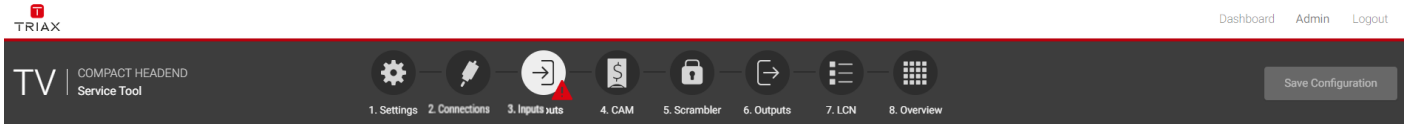

If there is an error in any part of the configuration, the user interface indicates this with a  symbol in the relevant sector of the navigation menu. In other parts of the user interface the error symbol is also used to indicate an error or configuration failure.

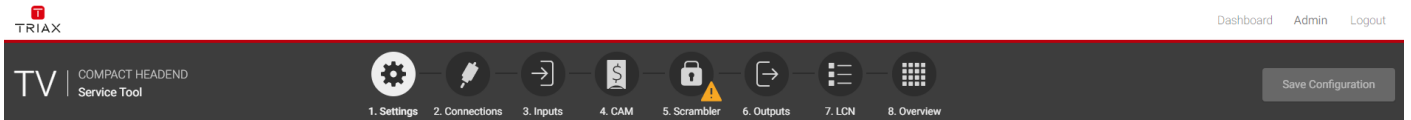

Any warnings are indicated by a  symbol.

### 5.2.2 Save configuration

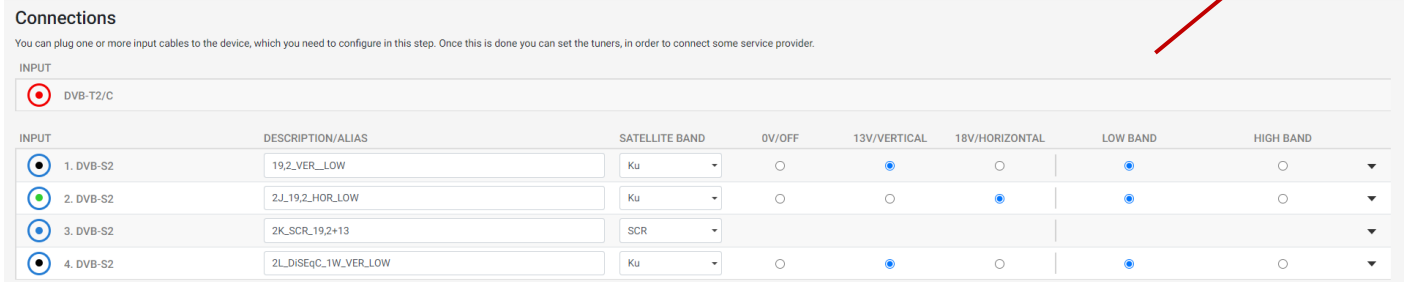
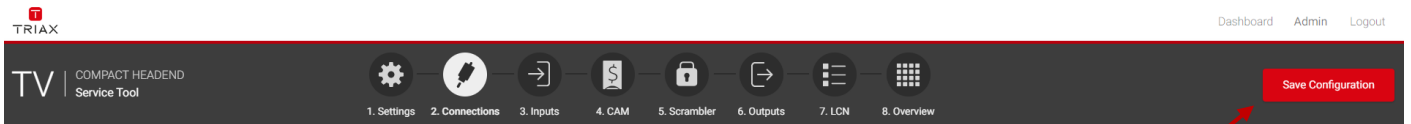

An important button when you change your configuration of the headend system is the “Save Configuration” button placed in the upper right-hand corner of the Service Tool window.

Whenever you have made changes in your configuration, the “Save Configuration” button turns red to tell you that you have unsaved changes that need to be saved.

Click the “Save Configuration” button to save the changes. When changes have been saved, the “Save Configuration” button loses the red colour.

### 5.2.3 Admin options

To enter the Admin options you need to Login.

At the top right you can switch between the Dashboard and the Configuration.

### 5.2.4 Dashboard

There are two possibilities to open the Dashboard overview of a TDcH or TDmH unit.

- When logged in, it is possible to open the Dashboard by pressing the Dashboard in the Administrator menu at the top right corner.
- You can open the Dashboard from the login page at the top right corner.

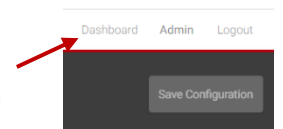

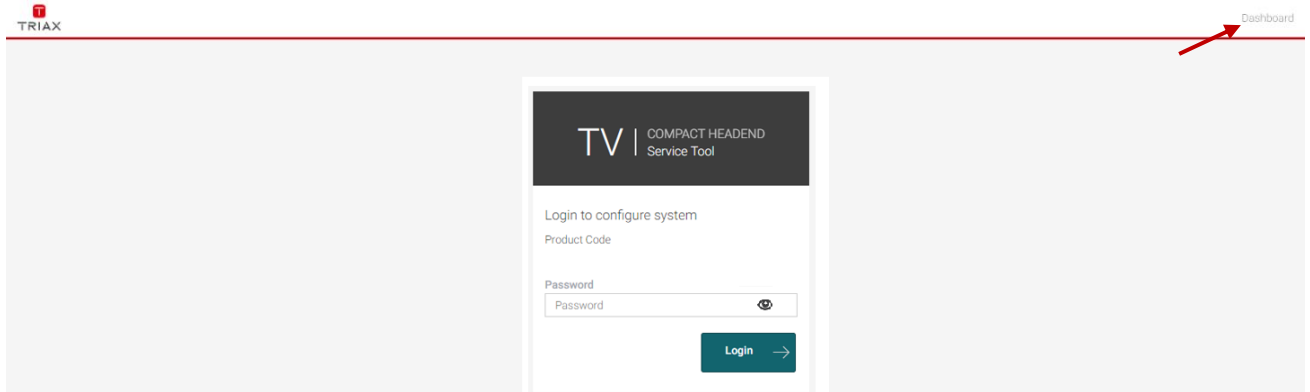

**Note:**

For the Dashboard, it is not required to log in and to know the password.

The entered password can be seen if you press the eye.

This Dashboard can be used by hotel employees to see an overview during a failure analysis or report an issue to the installer.

In the Dashboard view you will find the overall TV Status. The window is divided in two sectors. The left side shows all notifications of the last 24 hours and the right side shows a status on TV service level.

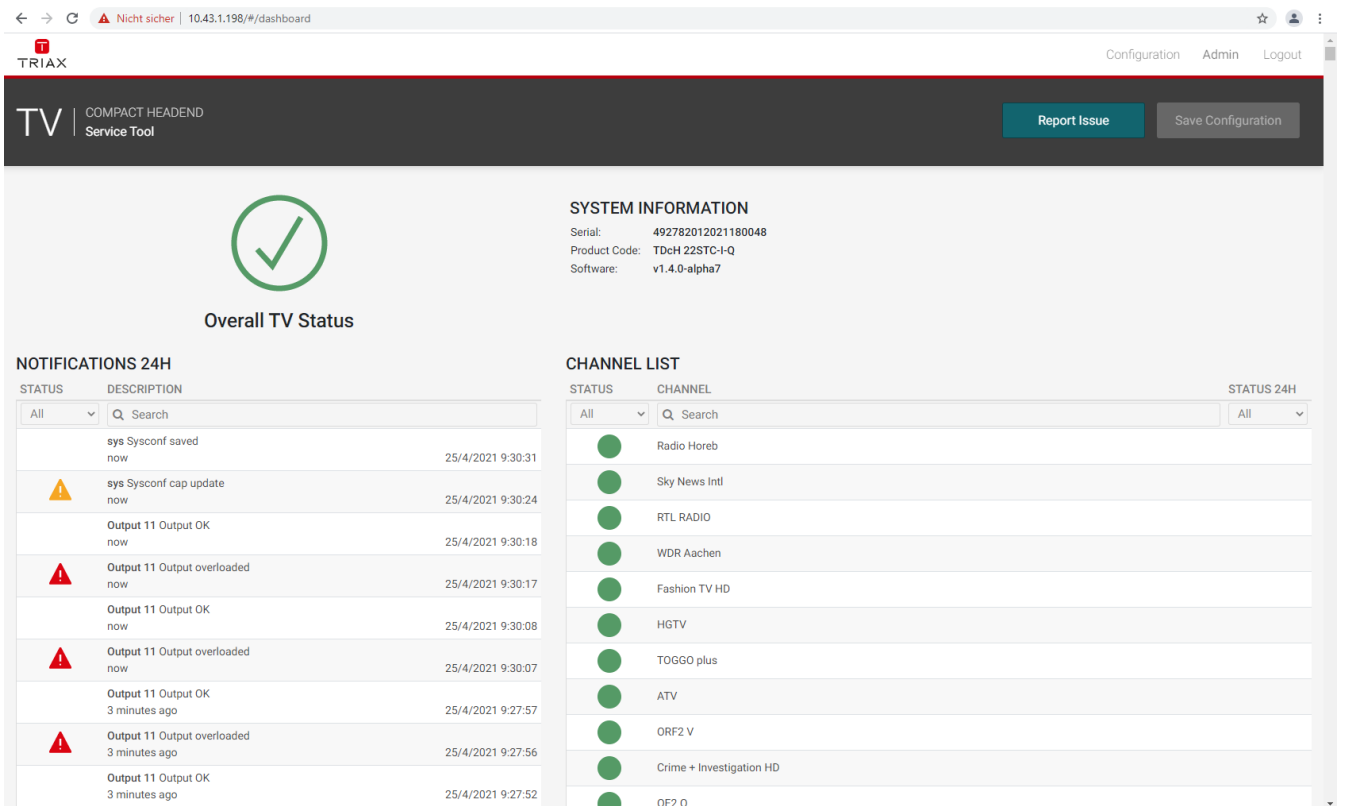



### 5.2.5 Channel Status Details

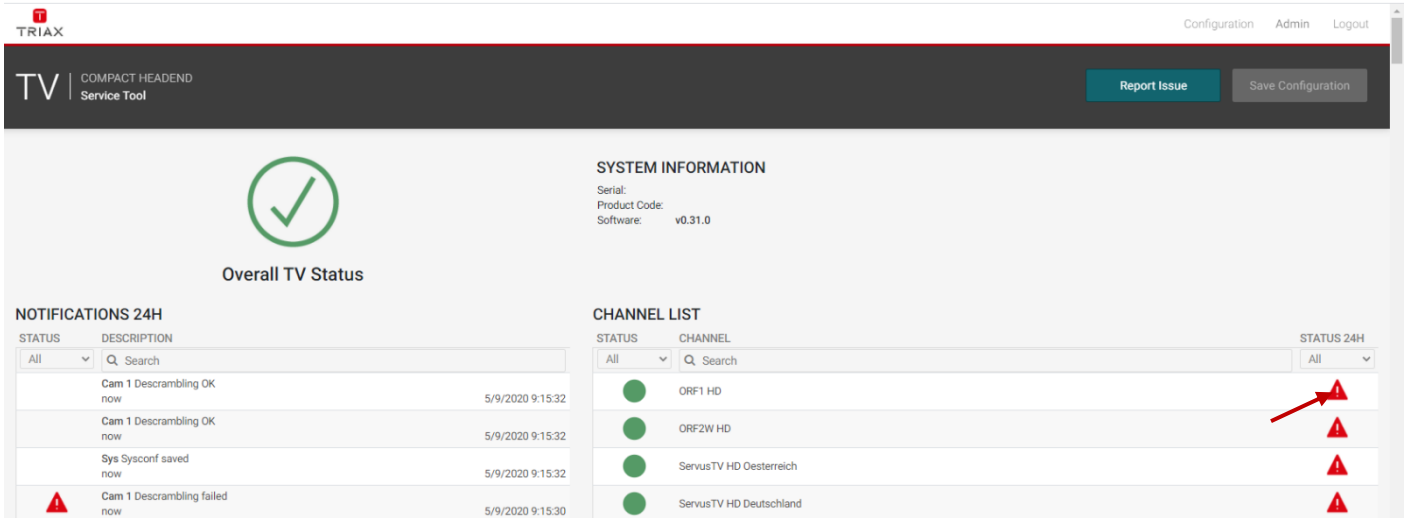

When you are in the Dashboard mode and click on the error indication on the right side, a Channel Status Details window will pop up.

In this window you can find the status over the last 24 hours.

The window also shows where the failure has occurred, such as the tuner, CAM or output.

This also helps to evaluate where the errors took place and the possible reasons for the failure.

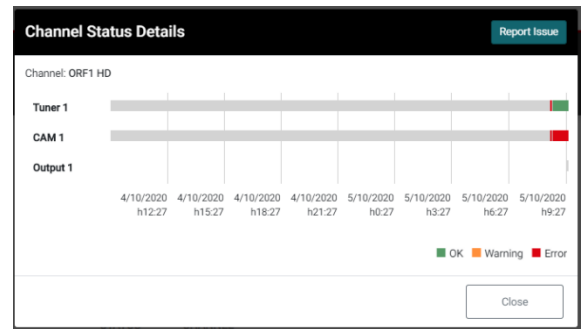

### 5.2.6 Report Issue

By pressing the report issue button, a window opens where you can download the log file. Please send us the log file together with your issue explanation.

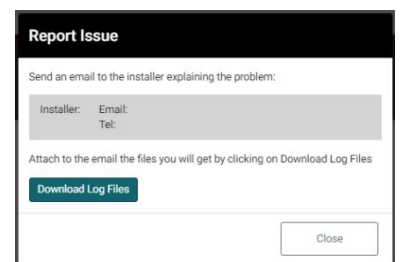

### 5.2.7 Admin menu

In the Admin Menu you have the option to Export the current configuration, import a configuration file, and clear the configuration.

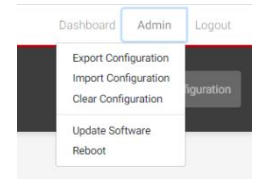

#### Export Configuration

Export the configuration from the TDcH & TDmH system to the download folder on the connected PC.

*Note:*

The configuration file is not human readable!

#### Import Configuration

Import a configuration file from the connected PC to the TDcH & TDmH system.

*Note:*

Configuration files can only be loaded from the same TDcH & TDmH model!

As an example:

- TDcH22STC-I config can be loaded at a TDcH22STC-I system
- TDcH22STC-I config **can NOT** be loaded at a TDcH16S-I

*Note:*

A configuration file from a system with a license required feature activated can be loaded to a system that does not have this feature activated via a license. The system however will show an error message indicating the missing license. There are then two options: a) buy and install the missing license, or b) delete the configuration for the current feature e.g. IPin, IPout, SNMP or Scrambling.

#### Clear Configuration

Clear the configuration at the system.

*Note:*

The function "Clear Configuration" will delete the configuration, set the IP address to the default IP address and also set the password to the default password!

#### Download Log Files

Function to download the log file of the compact headend.

#### Download Equipment File

Function to download the Equipment file of the compact headend.

*Note:*

The Equipment file is needed to generate a license in the PRT tool (Product Registration Tool).

## Licenses

Licenses can be ordered. To order a license the equipment file is needed.

After the order process, the user receives a license file which will have to be loaded to the compact Headend the License was generated for.

*Note:*

The license cannot be used for any other compact headend with a different serial number

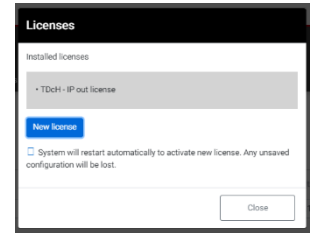

## Update Software

It is possible to update the software. The system will automatic reboot after update.

## Reboot

*Note:*

During reboot any unsaved configuration will be lost.

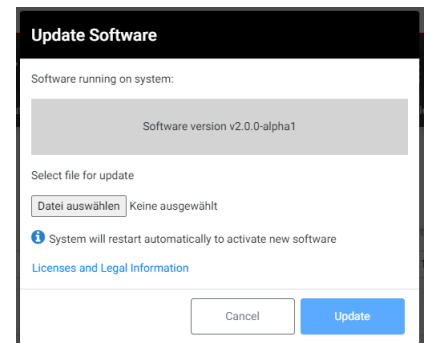

## 5.3 Settings

Start with the folder “Settings” to set up the general settings and information of the TDCh & TDmH headend.

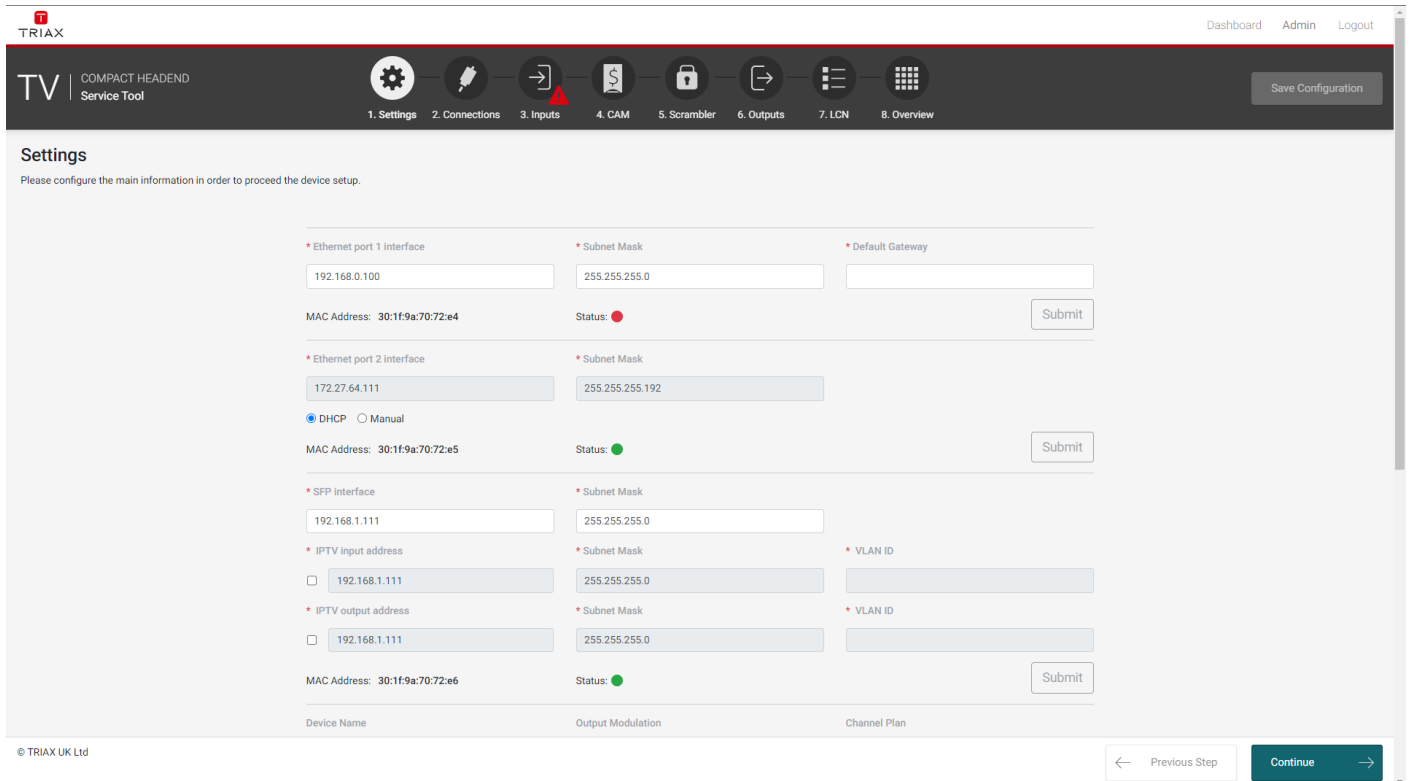

**Settings**  
Please configure the main information in order to proceed the device setup.

\* Ethernet port 1 interface: 192.168.0.100  
 \* Subnet Mask: 255.255.255.0  
 \* Default Gateway:   
 MAC Address: 30:1f:9a:70:72:e4 Status: ●

\* Ethernet port 2 interface: 172.27.64.111  
 \* Subnet Mask: 255.255.255.192  
 DHCP  Manual  
 MAC Address: 30:1f:9a:70:72:e5 Status: ●

\* SFP interface: 192.168.1.111  
 \* Subnet Mask: 255.255.255.0

\* IPTV input address:  192.168.1.111  
 \* Subnet Mask: 255.255.255.0  
 \* VLAN ID:

\* IPTV output address:  192.168.1.111  
 \* Subnet Mask: 255.255.255.0  
 \* VLAN ID:   
 MAC Address: 30:1f:9a:70:72:e6 Status: ●

Device Name:  Output Modulation:  Channel Plan:

© TRIAX UK Ltd

### 5.3.1 Ethernet Port 1 (Management Port)

#### Ethernet port 1 interface

This is the IP address of the Management port (Ethernet 1) of the compact Headend.

It may be necessary to specify a specific IP addresses for the headend to avoid network IP address conflicts.



#### Note:

If a PC is connected direct to the Management port with an Ethernet cable, the network address of the PC has to be in the same range as the compact headend.

The TDCh & TDmH management port IP addresses can be reset to factory default settings if required. This is done via the reset button on the headend unit.

#### Subnet Mask

This is the Subnet Mask for the network the Management Port is connected to.

#### Default Gateway

This is the Default Gateway in the network the Management Port is connected to.

**MAC Address:**

MAC address of this interface.

**Status:**

Green indicates this interface is connected.

**5.3.2 System reset**

The following reset functions are available:



1. *Factory defaults:*

When the reset button is pressed (during start up) and until the LED flashes green, then the system resets to factory defaults.

2. *Recovery mode:*

When the reset button is pressed (during start up) even longer until the LED flashes red, then the system starts in recovery mode. The system can be accessed at Ethernet port 1 at the default address.

**5.3.3 Ethernet port 2**

This is the IP address of the Ethernet port 2 of the compact Headend.



It may be necessary to specify a specific IP address for the headend to avoid network IP address conflicts.

*Note:*

The Port 2 can be managed manual and as DHCP server!

**Subnet Mask**

This is the Subnet Mask for the network the Port 2 is connected to.

**MAC Address:**

MAC address of this interface.

**Status:**

Green indicates this interface is connected.

**5.3.4 SFP interface**

This is the IP address of the SFP interface of the compact Headend. This interface is used for IPTV input and output.



**Subnet Mask**

This is the Subnet Mask for the network the SFP interface is connected to.

**MAC Address:**

MAC address of this interface.

**Status:**

Green indicates this interface is connected.

### 5.3.5 VLAN at SFP interface

The SFP interface offers an option for VLAN, where one VLAN can be used for IPTV input and another can be used for IPTV output. The same VLAN can also be used for both IPTV input and output.

As an configuration example IPTV can be received at a VLAN like shown in the configuration below where it is received at VLAN ID “1111”. IPTV output will be streamed VLAN untagged in this example.

* SFP interface	* Subnet Mask	
<input type="text" value="169.254.1.1"/>	<input type="text" value="255.255.0.0"/>	
* IPTV input address	* Subnet Mask	* VLAN ID
<input checked="" type="checkbox"/> <input type="text" value="169.254.1.2"/>	<input type="text" value="255.255.0.0"/>	<input type="text" value="1111"/>
* IPTV output address	* Subnet Mask	* VLAN ID
<input type="checkbox"/> <input type="text" value="169.254.1.1"/>	<input type="text" value="255.255.0.0"/>	<input type="text"/>
MAC Address: 30:1f:9a:74:d5:f3	Status: <span style="color: green;">●</span>	<input type="button" value="Submit"/>

If required, the IPTV output can also be streamed on its own VLAN, as shown below where the VLAN ID for IPTV output is specified to “2222”.

* SFP interface	* Subnet Mask	
<input type="text" value="169.254.1.1"/>	<input type="text" value="255.255.0.0"/>	
* IPTV input address	* Subnet Mask	* VLAN ID
<input checked="" type="checkbox"/> <input type="text" value="169.254.1.2"/>	<input type="text" value="255.255.0.0"/>	<input type="text" value="1111"/>
* IPTV output address	* Subnet Mask	* VLAN ID
<input checked="" type="checkbox"/> <input type="text" value="169.254.1.3"/>	<input type="text" value="255.255.0.0"/>	<input type="text" value="2222"/>
MAC Address: 30:1f:9a:74:d5:f3	Status: <span style="color: green;">●</span>	<input type="button" value="Submit"/>

If VLAN is not selected for either IPTV input or output, IPTV data will be received/streamed VLAN untagged.

### 5.3.6 Device Name

Description field to give the compact Headend or project any name.

### 5.3.7 Output Modulation

The TDcH & TDmH (except TDcH 16S-I-Q and TDcH 16S-Q models) support QAM and COFDM modulation. With this menu it is possible to switch between the QAM and COFDM output modulation.

**It is important to ensure the modulation is set correct before continuing.**

*Note:*

**If the output modulation is changed all configuration will be deleted and a restart is needed!**

A Warning message will be shown.

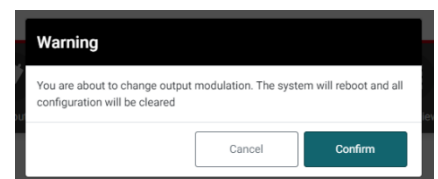

### 5.3.8 Channel Plan

Click on the “Channel Plan” field to open the drop down and select the Channel Plan you would like to use.

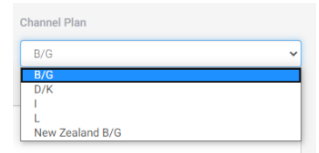

#### Channel Plan description:

System B/G		System I		System D/K		System L		System B/G New Zealand	
Name	Centre frequency	Name	Centre frequency	Name	Centre frequency	Name	Centre frequency	Name	Centre frequency
S-21	306,00	S-21	306,00	S-21	306,00	S-21	306,00	CH21	474,00
S-22	314,00	S-22	314,00	S-22	314,00	S-22	314,00	CH22	482,00
S-23	322,00	S-23	322,00	S-23	322,00	S-23	322,00	CH23	490,00
S-24	330,00	S-24	330,00	S-24	330,00	S-24	330,00	CH24	498,00
S-25	338,00	S-25	338,00	S-25	338,00	S-25	338,00	CH25	506,00
S-26	346,00	S-26	346,00	S-26	346,00	S-26	346,00	CH26	514,00
S-27	354,00	S-27	354,00	S-27	354,00	S-27	354,00	CH27	522,00
S-28	362,00	S-28	362,00	S-28	362,00	S-28	362,00	CH28	530,00
S-29	370,00	S-29	370,00	S-29	370,00	S-29	370,00	CH29	538,00
S-30	378,00	S-30	378,00	S-30	378,00	S-30	378,00	CH30	546,00
S-31	386,00	S-31	386,00	S-31	386,00	S-31	386,00	CH31	554,00
S-32	394,00	S-32	394,00	S-32	394,00	S-32	394,00	CH32	562,00
S-33	402,00	S-33	402,00	S-33	402,00	S-33	402,00	CH33	570,00
S-34	410,00	S-34	410,00	S-34	410,00	S-34	410,00	CH34	578,00
S-35	418,00	S-35	418,00	S-35	418,00	S-35	418,00	CH35	586,00
S-36	426,00	S-36	426,00	S-36	426,00	S-36	426,00	CH36	594,00
S-37	434,00	S-37	434,00	S-37	434,00	S-37	434,00	CH37	602,00
S-38	442,00	S-38	442,00	S-38	442,00	S-38	442,00	CH38	610,00
S-39	450,00	S-39	450,00	S-39	450,00	S-39	450,00	CH39	618,00
S-40	458,00	S-40	458,00	S-40	458,00	S-40	458,00	CH40	626,00
S-41	466,00	S-41	466,00	S-41	466,00	S-41	466,00	CH41	634,00
CH21	474,00	CH21	474,00	CH21	474,00	CH21	474,00	CH42	642,00
CH22	482,00	CH22	482,00	CH22	482,00	CH22	482,00	CH43	650,00
CH23	490,00	CH23	490,00	CH23	490,00	CH23	490,00	CH44	658,00
CH24	498,00	CH24	498,00	CH24	498,00	CH24	498,00	CH45	666,00
CH25	506,00	CH25	506,00	CH25	506,00	CH25	506,00	CH46	674,00
CH26	514,00	CH26	514,00	CH26	514,00	CH26	514,00	CH47	682,00
CH27	522,00	CH27	522,00	CH27	522,00	CH27	522,00	CH48	690,00
CH28	530,00	CH28	530,00	CH28	530,00	CH28	530,00	CH49	698,00
CH29	538,00	CH29	538,00	CH29	538,00	CH29	538,00	CH50	706,00
CH30	546,00	CH30	546,00	CH30	546,00	CH30	546,00	CH51	714,00
CH31	554,00	CH31	554,00	CH31	554,00	CH31	554,00	CH52	722,00
CH32	562,00	CH32	562,00	CH32	562,00	CH32	562,00	CH53	730,00
CH33	570,00	CH33	570,00	CH33	570,00	CH33	570,00	CH54	738,00
CH34	578,00	CH34	578,00	CH34	578,00	CH34	578,00	CH55	746,00
CH35	586,00	CH35	586,00	CH35	586,00	CH35	586,00	CH56	754,00
CH36	594,00	CH36	594,00	CH36	594,00	CH36	594,00	CH57	762,00
CH37	602,00	CH37	602,00	CH37	602,00	CH37	602,00	CH58	770,00
CH38	610,00	CH38	610,00	CH38	610,00	CH38	610,00	CH59	778,00
CH39	618,00	CH39	618,00	CH39	618,00	CH39	618,00	CH60	786,00

System B/G		System I		System D/K		System L		System B/G New Zealand	
Name	Centre frequency	Name	Centre frequency	Name	Centre frequency	Name	Centre frequency	Name	Centre frequency
CH40	626,00	CH40	626,00	CH40	626,00	CH40	626,00	CH61	794,00
CH41	634,00	CH41	634,00	CH41	634,00	CH41	634,00	CH62	802,00
CH42	642,00	CH42	642,00	CH42	642,00	CH42	642,00	CH63	810,00
CH43	650,00	CH43	650,00	CH43	650,00	CH43	650,00	CH64	818,00
CH44	658,00	CH44	658,00	CH44	658,00	CH44	658,00	CH65	826,00
CH45	666,00	CH45	666,00	CH45	666,00	CH45	666,00	CH66	834,00
CH46	674,00	CH46	674,00	CH46	674,00	CH46	674,00	CH67	842,00
CH47	682,00	CH47	682,00	CH47	682,00	CH47	682,00	CH68	850,00
CH48	690,00	CH48	690,00	CH48	690,00	CH48	690,00	CH69	858,00
CH49	698,00	CH49	698,00	CH49	698,00	CH49	698,00		
CH50	706,00	CH50	706,00	CH50	706,00	CH50	706,00		
CH51	714,00	CH51	714,00	CH51	714,00	CH51	714,00		
CH52	722,00	CH52	722,00	CH52	722,00	CH52	722,00		
CH53	730,00	CH53	730,00	CH53	730,00	CH53	730,00		
CH54	738,00	CH54	738,00	CH54	738,00	CH54	738,00		
CH55	746,00	CH55	746,00	CH55	746,00	CH55	746,00		
CH56	754,00	CH56	754,00	CH56	754,00	CH56	754,00		
CH57	762,00	CH57	762,00	CH57	762,00	CH57	762,00		
CH58	770,00	CH58	770,00	CH58	770,00	CH58	770,00		
CH59	778,00	CH59	778,00	CH59	778,00	CH59	778,00		
CH60	786,00	CH60	786,00	CH60	786,00	CH60	786,00		
CH61	794,00	CH61	794,00	CH61	794,00	CH61	794,00		
CH62	802,00	CH62	802,00	CH62	802,00	CH62	802,00		
CH63	810,00	CH63	810,00	CH63	810,00	CH63	810,00		
CH64	818,00	CH64	818,00	CH64	818,00	CH64	818,00		
CH65	826,00	CH65	826,00	CH65	826,00	CH65	826,00		
CH66	834,00	CH66	834,00	CH66	834,00	CH66	834,00		
CH67	842,00	CH67	842,00	CH67	842,00	CH67	842,00		
CH68	850,00	CH68	850,00	CH68	850,00	CH68	850,00		
CH69	858,00	CH69	858,00	CH69	858,00	CH69	858,00		
						CH70	866,00		
						CH71	874,00		
						CH72	882,00		

### 5.3.9 Language

Possibility to change the language of the user interface between English, German and French.



### 5.3.10 Timezone

Click on the “Timezone” field to open the drop down and select the time zone where the compact headend is installed.

The time zone is important because this sets up the time offset which is added to the UTC time received with the service and sent out in the TOT to the TV.

**Note:**

Please test after the final installation if the time shown on the TV or in the EPG menu of the TV corresponds to the local time.

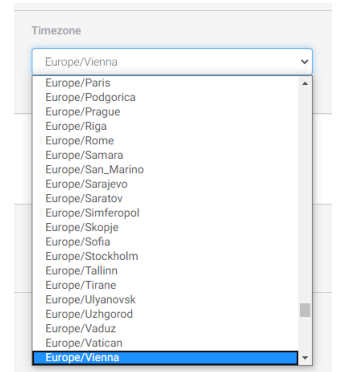

### 5.3.11 Time / internal clock

The internal clock in the system runs via a RTC. After a power cycle the clock will automatically continue.

The internal clock needs to be synchronized and initialized. If the clock is not synchronized it will drift and e.g. increase with ~ 1 minute pr. 24 hours, resulting in wrong time at the TV sets and EIT mismatch because of not aligned TDT at the output of the TDcH/TDmH.

Clock synchronization is done via a one of following options:

- a) Via NTP (prioritized)
- b) Via TDT in received transport stream

#### **Clock synchronization via NTP**

The NTP time shall be received either at Ethernet port 1 interface or Ethernet port 2 interface. The NTP server is automatically selected from the network configuration information in the DHCP response. If no valid DHCP response information is received, then the system will default to [time1.google.com](http://time1.google.com), [time2.google.com](http://time2.google.com), [time3.google.com](http://time3.google.com), or [time4.google.com](http://time4.google.com).

If the NTP time shall be received via the Ethernet port 1 interface then this port must be connected to the network and a valid and existing “Default gateway” must be configured for this port.

If the NTP time shall be received via the Ethernet port 2 interface then this port must be connected to the network and “DHCP” must be configured for this port.

#### **Clock synchronization via TDT in received transport stream**

The TDT in a received transport stream can also be used to synchronize the clock. The system automatically selects the TDT with the lowest jitter. The received transport stream can be received by any RF input (DVB-S2X or DVB-T2 or DVB-C). From SW v3.1.0 IP inputs are also supported as TDT source for clock synchronization.

### 5.3.12 Country

Define the country in which the headend is installed.

**Note:**

This setting is also important to have the right time zone settings!

### 5.3.13 Device Description

Text field for project description and notes.

### 5.3.14 Installer

Text field for the installer or company name who is responsible for the installation.

### 5.3.15 Installer Email and Phone

Text field for the email address and phone number of the installer.

*Note:*

Please note that this information is used in the report Issue window which can be accessed from the Dashboard.

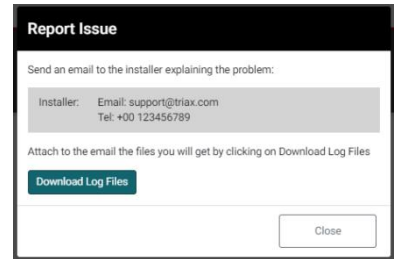

### 5.3.16 SNMP

Option to enable SNMP and set address port to the SNMP monitor.

### 5.3.17 Change Password

The first time you login to the headend, you must change the password to a unique password by following these steps:

1. Specify a new password in the “Change Password” field.
2. Re-specify the new password in the “Confirm New Password” field.
3. Press submit to change the password.

## 5.4 Input connections

### 5.4.1 DVB-T2/C input

The TDcH 22STC-I and TDmH 14STC-I headends have 1 Terrestrial / Cable input marked with DVB-T2/C and a red colour ring.



**Note:**

The Input has an LED indicator.

Black (off) indicates no tuners configured to use this input.

Green indicates OK for all tuners configured to use this input.

Red indicates error for one or more tuners configured to use this input.

### 5.4.2 DVB-S2X inputs

The TDcH & TDmH headend (except the TDmH IP model) has 4 SAT-IF inputs marked with DVB-S2X and a blue colour ring.



**Note:**

The Inputs have an LED indicator.

Black (off) indicates no tuners configured to use this input.

Green indicates OK for all tuners configured to use this input.

Red indicates error for one or more tuners configured to use this input.

### 5.4.3 Connections in GUI

Open the folder “Connections” to set up the DVB-S2X input configuration.

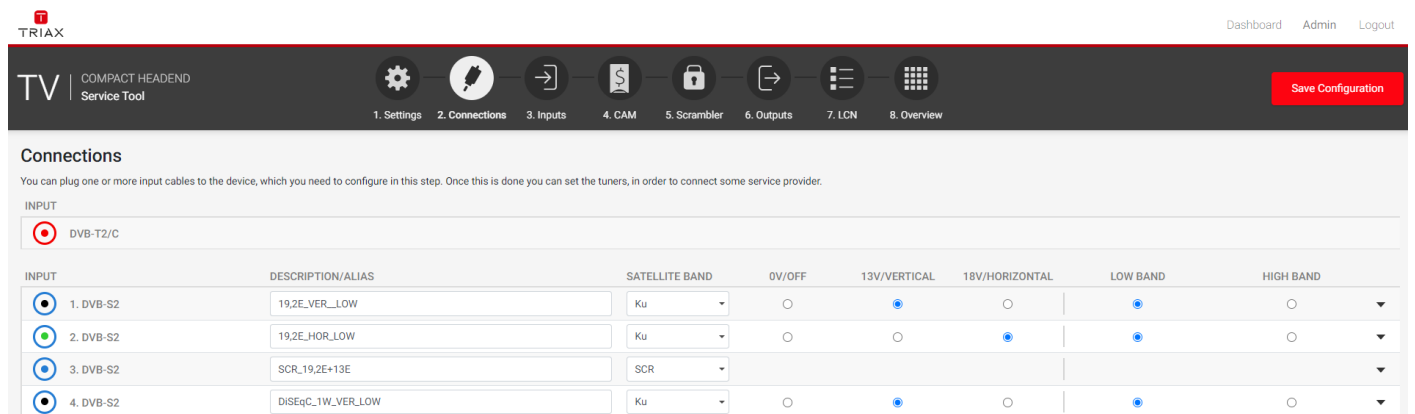

**Connections**

You can plug one or more input cables to the device, which you need to configure in this step. Once this is done you can set the tuners, in order to connect some service provider.

INPUT

1. Settings 2. Connections 3. Inputs 4. CAM 5. Scrambler 6. Outputs 7. LCN 8. Overview

Save Configuration

INPUT	DESCRIPTION/ALIAS	SATELLITE BAND	0V/OFF	13V/VERTICAL	18V/HORIZONTAL	LOW BAND	HIGH BAND
1. DVB-S2	19,2E_VER_LOW	Ku	<input type="radio"/>	<input checked="" type="radio"/>	<input type="radio"/>	<input checked="" type="radio"/>	<input type="radio"/>
2. DVB-S2	19,2E_HOR_LOW	Ku	<input type="radio"/>	<input type="radio"/>	<input checked="" type="radio"/>	<input checked="" type="radio"/>	<input type="radio"/>
3. DVB-S2	SCR_19,2E+13E	SCR	<input type="radio"/>	<input type="radio"/>	<input type="radio"/>	<input type="radio"/>	<input type="radio"/>
4. DVB-S2	DiSeqC_1W_VER_LOW	Ku	<input type="radio"/>	<input checked="" type="radio"/>	<input type="radio"/>	<input checked="" type="radio"/>	<input type="radio"/>

### 5.4.4 Description/Alias

The DVB-S2X inputs can be configured with an alias. This alias is shown in other panes in the GUI, thus it is possible to give the input an alias that describes the source for the input.

E.g. "19,2E\_VER\_LOW" could describe the 19,2° East – Vertical polarisation – Low band.

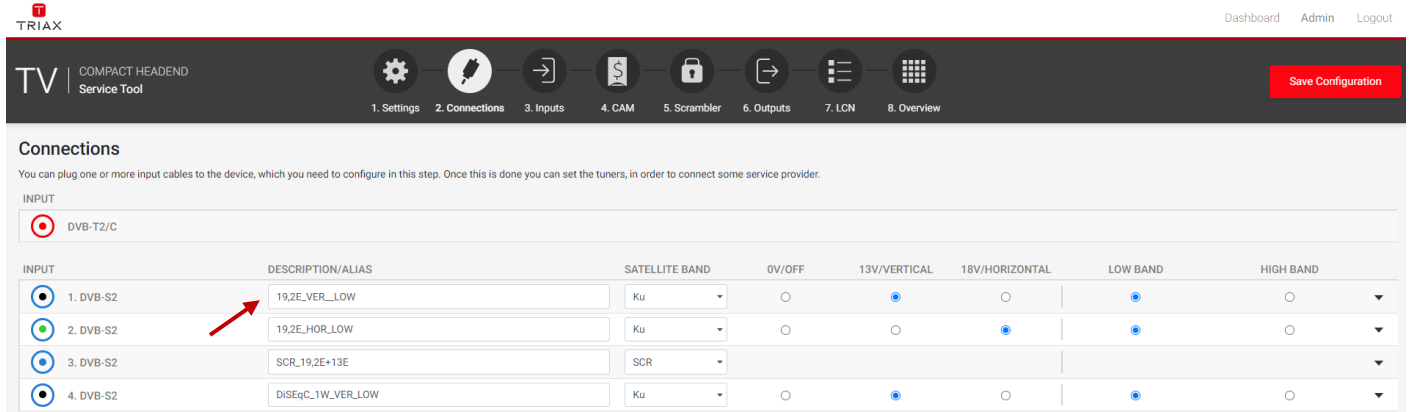

### 5.4.5 Single Satellite Reception

Select the required parameters for each DVB-S2X input:

- Satellite Band      Ku, K, C or SCR (See multi satellite reception)
- 13V/18V              for Vertical or Horizontal polarisation
- LOW/HIGH            for the Band

**Note:**

The input colour shows the setting following the same colour codes TRIAX uses on LNBS and multi-switches.

	<p><b>Yellow:</b>      Horizontal, High Band</p> <p><b>Red:</b>            Vertical, High Band</p> <p><b>Green:</b>        Horizontal, Low Band</p> <p><b>Black:</b>         Vertical, Low Band</p>
--	---

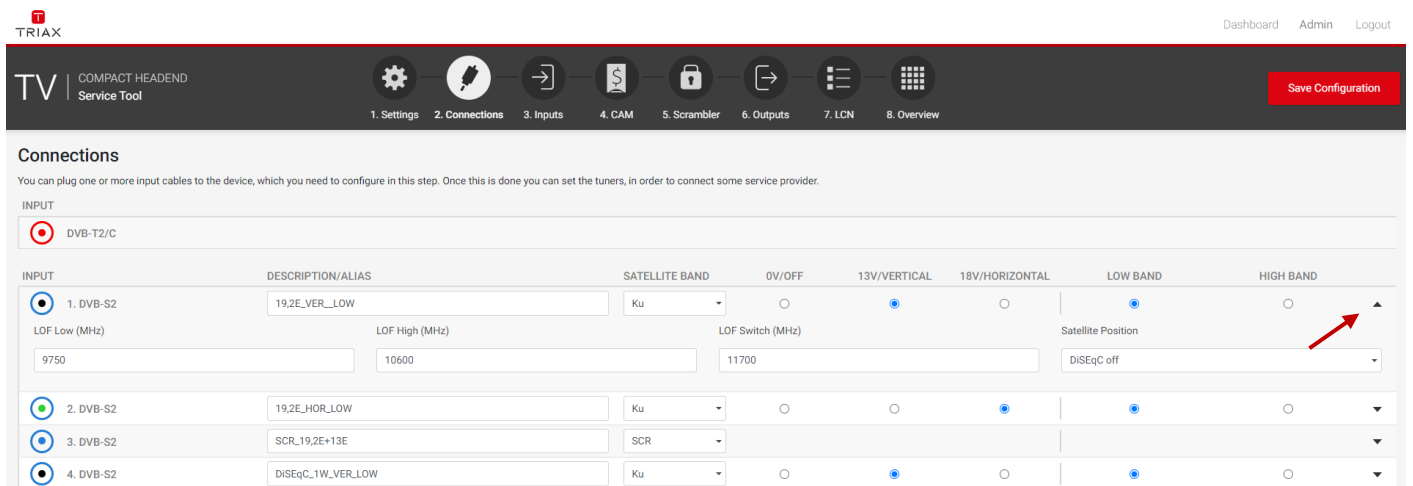

When you press the expand button you can open the DiSEqC settings:

INPUT	DESCRIPTION/ALIAS	SATELLITE BAND	0V/OFF	13V/VERTICAL	18V/HORIZONTAL	LOW BAND	HIGH BAND
1. DVB-S2 LOF Low (MHz) 9750	19,2E_VER_LOW LOF High (MHz) 10600	Ku	<input type="radio"/>	<input checked="" type="radio"/>	<input type="radio"/>	<input checked="" type="radio"/>	<input type="radio"/>
2. DVB-S2	19,2E_HOR_LOW	Ku	<input type="radio"/>	<input type="radio"/>	<input checked="" type="radio"/>	<input type="radio"/>	<input type="radio"/>
3. DVB-S2	SCR_19,2E+13E	SCR	<input type="radio"/>	<input type="radio"/>	<input type="radio"/>	<input type="radio"/>	<input type="radio"/>
4. DVB-S2	DiSeqC_1W_VER_LOW	Ku	<input type="radio"/>	<input checked="" type="radio"/>	<input type="radio"/>	<input checked="" type="radio"/>	<input type="radio"/>

Satellite Position  
 DiSeqC off  
 1/A  
 2/B  
 3/C  
 4/D

DiSEqC supports four satellite positions. Please select the desired position if required.

**Note:**

Configure DiSEqC to 1/A, 2/B, 3/C or 4/D will result in DiSEqC commands at the DVB-S2X input describing the position.

Configure DiSEqC to "DiSEqC off" will result in no commands at all, hence no change at the multiswitch. So, changing e.g. 2/B position to "DiSEqC off" will result in the multiswitch still set to 2/B - after a general power failure resulting in both the multiswitch and the TDcH & TDmH power cycling then the multiswitch will start up in default e.g. 1/A resulting in wrong position → no signal at the TDcH & TDmH!

In addition to the DiSEqC settings, the menu also shows the (default) values of the (Local-Oscillator-Frequency)

- LOF Low:                      Local Oscillator Frequency for the low band Frequencies
- LOF High:                     Local Oscillator Frequency for the high band Frequencies
- LOF Switch:                  Border frequency between low and high band

**Note:**

The LOF frequencies can be adjusted to the requirements of the LNB.

### 5.4.6 Multiple satellite reception

To support SCR from the Satellite reception and distribution we recommend to use the following TRIAX products:

#### SCR LNB:

304847 SCR 2 1 SCR out 4 User bands

This LNB's can be directly connected to one of the TDcH & TDmH DVB-S2X inputs and allows reception of 4 transponders from one satellite independent from the polarization.

#### SCR Multi switch:

307356 TMU 1743C 4 SCR out 12 User bands each

This multi switch supports up to 4 satellite positions with up to 16 polarizations using 4 Quattro LNB's. The Quattro LNBs must support the LOF frequencies 9.75 / 10.6 GHz.

307348 TMU 943C 4 SCR out 12 User bands each

This multi switch supports up to 2 satellite positions with up to 8 polarizations using 2 Quattro LNB's. The Quattro LNBs must support the LOF frequencies 9.75 / 10.6 GHz.

318190 TdSCR 906C 6 SCR out 10 User bands each

This multi switch supports up to 2 satellite positions with up to 8 polarizations using 4 Quattro LNB's. The Quattro LNBs must support the LOF frequencies 9.75 / 10.6 GHz.  
Or up to 4 satellite positions with up to 16 polarizations using Wide Band LNB's.

#### Note:

The TDcH & TDmH support the following SCR standards:

- EN50494
- EN50607

If you set the DVB-S2X input to SCR the TDcH & TDmH supports SCR (Satellite Channel Router) functionality and can receive one satellite with up to four polarizations on this input. Each DVB-S2X input can be individually configured.

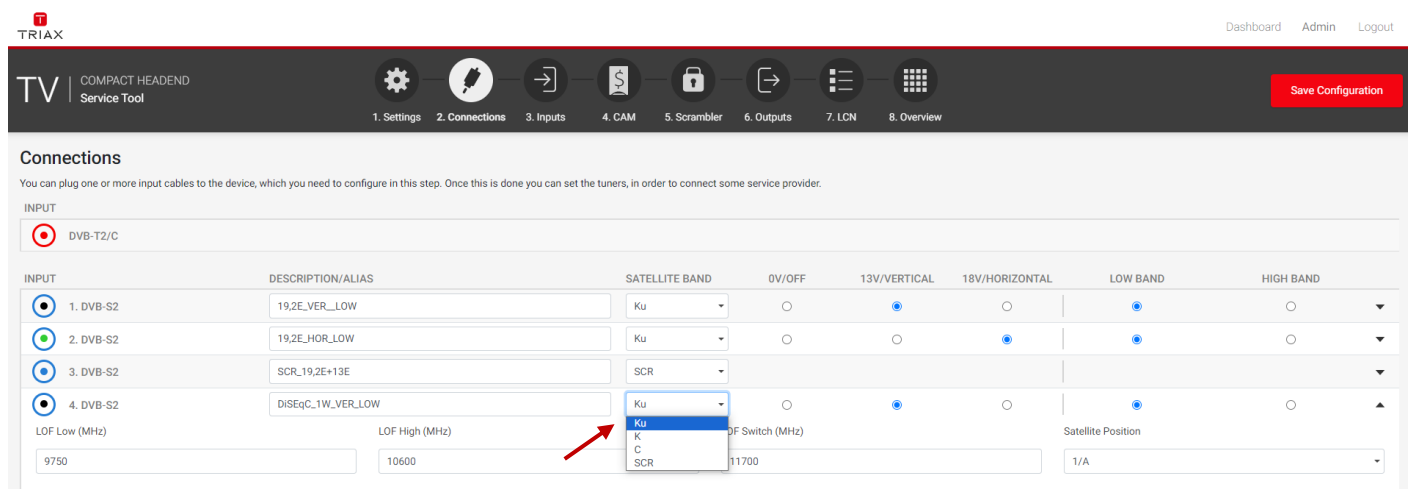

When you press the expand button you can open the SCR and LOF settings:

INPUT	DESCRIPTION/ALIAS	SATELLITE BAND	0V/OFF	13V/VERTICAL	18V/HORIZONTAL	LOW BAND	HIGH BAND
1. DVB-S2	19,2E_VER_LOW	Ku	<input type="radio"/>	<input checked="" type="radio"/>	<input type="radio"/>	<input checked="" type="radio"/>	<input type="radio"/>
2. DVB-S2	19,2E_HOR_LOW	Ku	<input type="radio"/>	<input type="radio"/>	<input checked="" type="radio"/>	<input checked="" type="radio"/>	<input type="radio"/>
3. DVB-S2	SCR_19,2E+13E	SCR					

LOF Low (MHz):       LOF High (MHz):       LOF Switch (MHz):

Center Frequencies (MHz)

UB 1:	<input type="text" value="1210"/>	UB 9:	<input type="text" value="1340"/>	UB 17:	<input type="text"/>	UB 25:	<input type="text"/>
UB 2:	<input type="text" value="1420"/>	UB 10:	<input type="text" value="1485"/>	UB 18:	<input type="text"/>	UB 26:	<input type="text"/>
UB 3:	<input type="text" value="1680"/>	UB 11:	<input type="text" value="1550"/>	UB 19:	<input type="text"/>	UB 27:	<input type="text"/>
UB 4:	<input type="text" value="2040"/>	UB 12:	<input type="text" value="1615"/>	UB 20:	<input type="text"/>	UB 28:	<input type="text"/>
UB 5:	<input type="text" value="985"/>	UB 13:	<input type="text" value="1745"/>	UB 21:	<input type="text"/>	UB 29:	<input type="text"/>
UB 6:	<input type="text" value="1050"/>	UB 14:	<input type="text" value="1810"/>	UB 22:	<input type="text"/>	UB 30:	<input type="text"/>
UB 7:	<input type="text" value="1115"/>	UB 15:	<input type="text" value="1875"/>	UB 23:	<input type="text"/>	UB 31:	<input type="text"/>
UB 8:	<input type="text" value="1275"/>	UB 16:	<input type="text" value="1940"/>	UB 24:	<input type="text"/>	UB 32:	<input type="text"/>

4. DVB-S2      DiSEqC\_1W\_VER\_LOW      Ku                             

The TDcH & TDmH SCR functionality supports up to 32 User bands per SCR input. The centre frequencies can be entered on the table as shown in the screen shot.

The Frequencies the SCR distribution equipment supports can be found on the product label or in the user manual of the used product.

In addition to the SCR user band settings, the menu also shows the (default) values of the (Local-Oscillator-Frequency)

LOF Low:                      Local Oscillator Frequency for the low band Frequencies

LOF High:                     Local Oscillator Frequency for the high band Frequencies

LOF Switch:                  Border frequency between low and high band

**Note:**

The LOF frequencies can be adjusted to the requirements of the used LNB. Starting a new configuration the LOF frequencies are set to the default values.

## 5.5 RF inputs

Click the “Inputs” folder in the Compact Headend Service Tool to display the RF Inputs window.

The “Inputs” page shows all RF input tuners. The colour of the tuner number shows the status of each tuner.

Grey: Tuner is not used

Red: Tuner is not set up correctly or input signal is missing.

Green: Tuner is locked and working.

The first time the Compact Headend Service Tool displays the tuner configuration window in a new configuration, the configuration fields and the list of services will be empty or display default values.



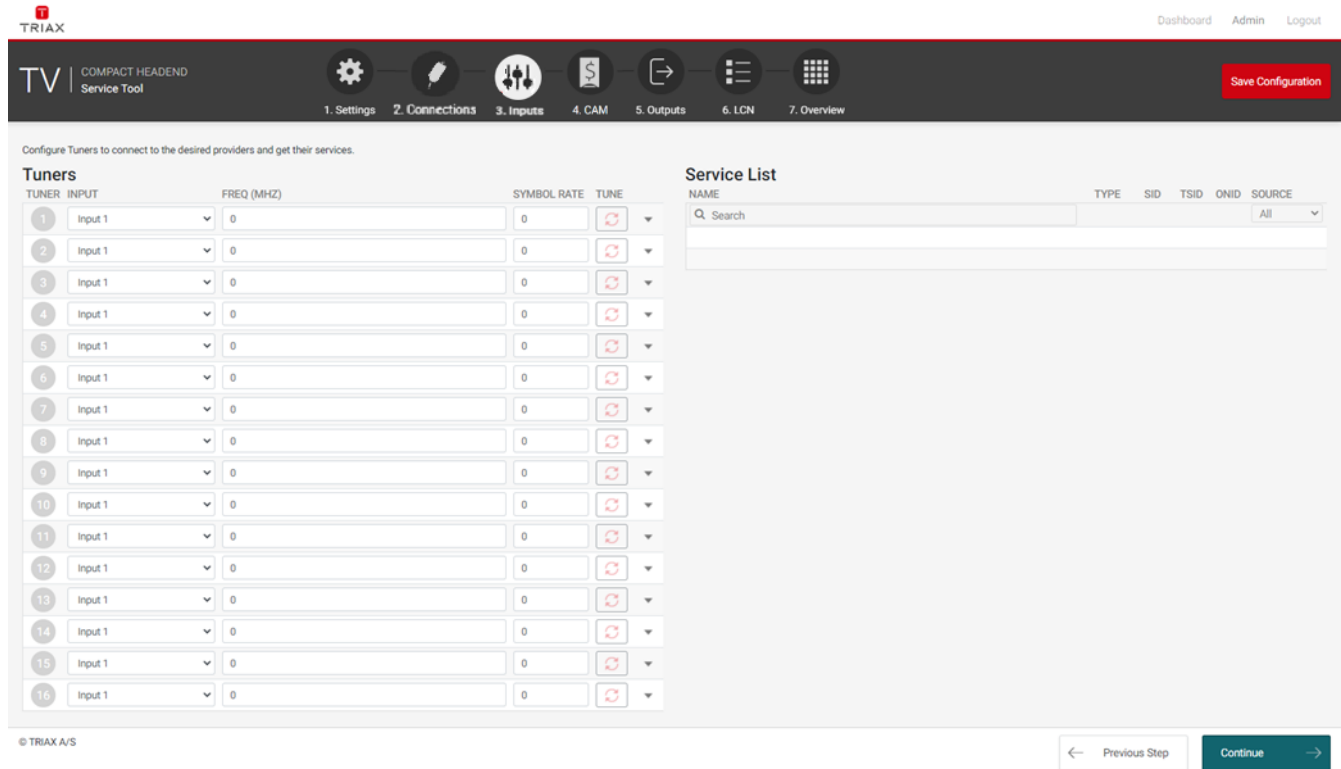

### 5.5.1 Terrestrial and Cable tuner setup

**Note:**

This functionality is only available on the Version TDcH 22STC-I and TDmH 14STC-I.

To set up a tuner you must follow the following steps:

1. Select the “Demodulation”:

TUNER	DEMODULATION	CHANNEL	BANDWIDTH	PLP	SYMBOL RATE	TUNE
TC1	DVB-T2	CH41 (634 MHz)	8 MHz	0		
TC2	DVB-T2 DVB-C	0 MHz	8 MHz	0		
TC3	DVB-T2	0 MHz	8 MHz	0		
TC4	DVB-T2	0 MHz	8 MHz	0		
TC5	DVB-C	0 MHz			6900	
TC6	DVB-C	0 MHz			6900	

To select the required demodulation, click on the demodulation field to open the drop-down list with demodulations you can choose from.

Select the demodulation you want to use.

- Enter the desired frequency in MHz in the channel field or select the corresponding channel from the dropdown list:

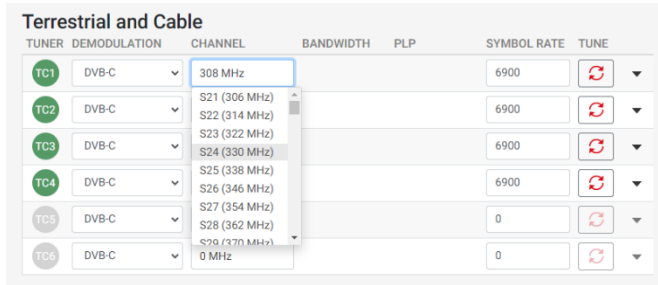

TUNER	DEMODULATION	CHANNEL	BANDWIDTH	PLP	SYMBOL RATE	TUNE
TC1	DVB-C	308 MHz			6900	[Tune]
TC2	DVB-C	S21 (306 MHz) S22 (314 MHz)			6900	[Tune]
TC3	DVB-C	S23 (322 MHz) S24 (330 MHz)			6900	[Tune]
TC4	DVB-C	S25 (338 MHz) S26 (346 MHz)			6900	[Tune]
TC5	DVB-C	S27 (354 MHz) S28 (362 MHz)			0	[Tune]
TC6	DVB-C	S29 (370 MHz) 0 MHz			0	[Tune]

- If the tuner is used as DVB-T/T2 then please select the required channel bandwidth and PLP number:

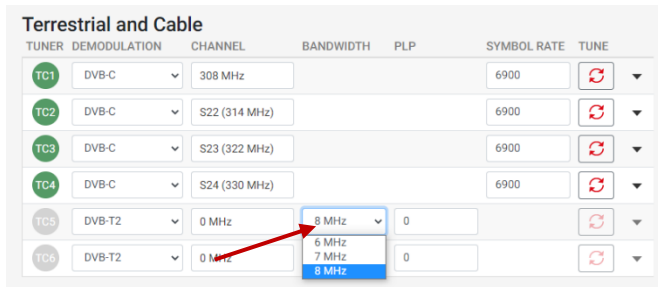

TUNER	DEMODULATION	CHANNEL	BANDWIDTH	PLP	SYMBOL RATE	TUNE
TC1	DVB-C	308 MHz			6900	[Tune]
TC2	DVB-C	S22 (314 MHz)			6900	[Tune]
TC3	DVB-C	S23 (322 MHz)			6900	[Tune]
TC4	DVB-C	S24 (330 MHz)			6900	[Tune]
TC5	DVB-T2	0 MHz	8 MHz	0		[Tune]
TC6	DVB-T2	0 MHz	0 MHz	0		[Tune]

- If the tuner is used as DVB-C then please select the required symbol rate:

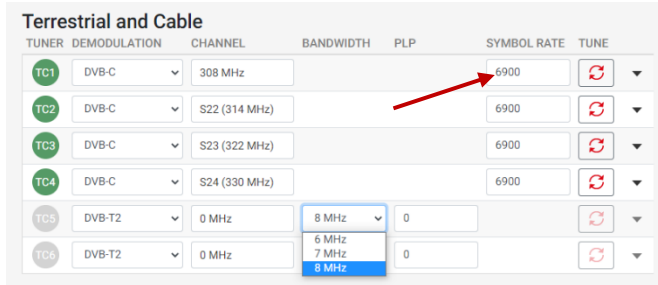

TUNER	DEMODULATION	CHANNEL	BANDWIDTH	PLP	SYMBOL RATE	TUNE
TC1	DVB-C	308 MHz			6900	[Tune]
TC2	DVB-C	S22 (314 MHz)			6900	[Tune]
TC3	DVB-C	S23 (322 MHz)			6900	[Tune]
TC4	DVB-C	S24 (330 MHz)			6900	[Tune]
TC5	DVB-T2	0 MHz	8 MHz	0		[Tune]
TC6	DVB-T2	0 MHz	0 MHz	0		[Tune]

- If an alternative EIT to the internal EIT in the current transport stream, press expand for the tuner and choose the alternative EIT source:

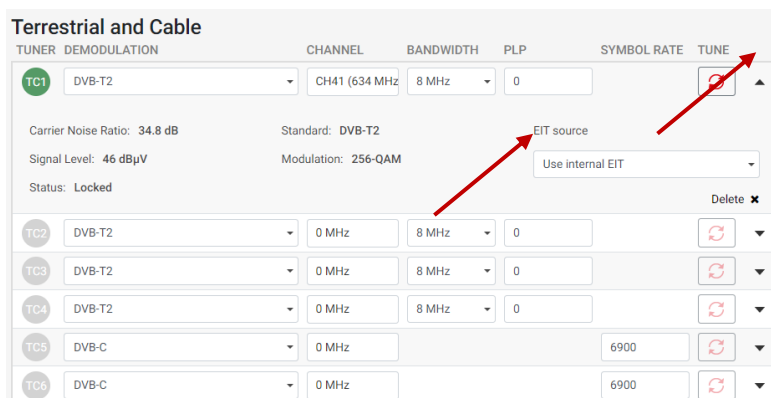

TUNER	DEMODULATION	CHANNEL	BANDWIDTH	PLP	SYMBOL RATE	TUNE
TC1	DVB-T2	CH41 (634 MHz)	8 MHz	0		[Tune]
Carrier Noise Ratio: 34.8 dB Signal Level: 46 dBµV Status: Locked Standard: DVB-T2 Modulation: 256-QAM EIT source: Use internal EIT						
TC2	DVB-T2	0 MHz	8 MHz	0		[Tune]
TC3	DVB-T2	0 MHz	8 MHz	0		[Tune]
TC4	DVB-T2	0 MHz	8 MHz	0		[Tune]
TC5	DVB-C	0 MHz			6900	[Tune]
TC6	DVB-C	0 MHz			6900	[Tune]

6. Click the “TUNE” button to activate the setting into the headend system:

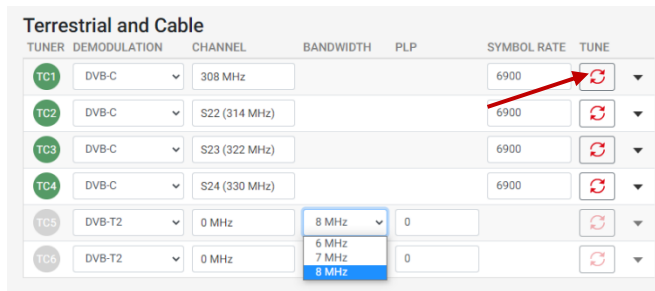

By clicking on the expand button, information details from the selected transponder will be shown:

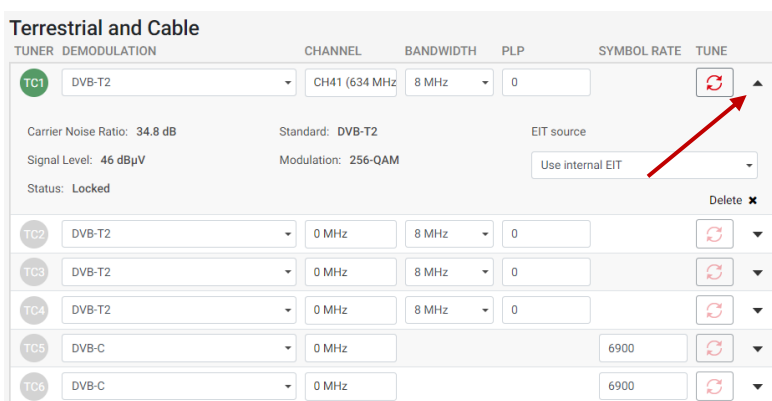

**Carrier Noise Ratio:** Shows the carrier to noise ratio of the input signal

**Signal Level:** Displays the actual signal level







**Standard:** Shows the standard of the input signal

**Modulation:** Shows the modulation of the input signal

**Status:** Shows the status of the tuner

To delete the tuner input, press the “Delete x”:

**Terrestrial and Cable**

TUNER	DEMODULATION	CHANNEL	BANDWIDTH	PLP	SYMBOL RATE	TUNE
TC1	DVB-T2	CH41 (634 MHz)	8 MHz	0		 ▲
Carrier Noise Ratio: 34.8 dB      Standard: DVB-T2      EIT source Signal Level: 46 dBµV      Modulation: 256-QAM      Use internal EIT						
Status: Locked <span style="float: right;">Delete x</span>						
TC2	DVB-T2	0 MHz	8 MHz	0		 ▼
TC3	DVB-T2	0 MHz	8 MHz	0		 ▼
TC4	DVB-T2	0 MHz	8 MHz	0		 ▼
TC5	DVB-C	0 MHz			6900	 ▼
TC6	DVB-C	0 MHz			6900	 ▼

A warning will appear:

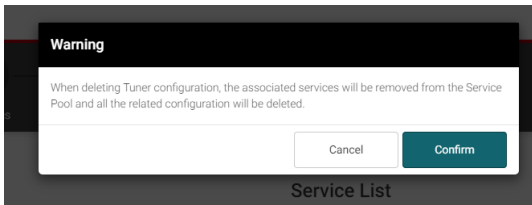

### 5.5.2 Satellite tuner setup

To set up a satellite tuner you must follow the following steps:

1. Select the “Input”:

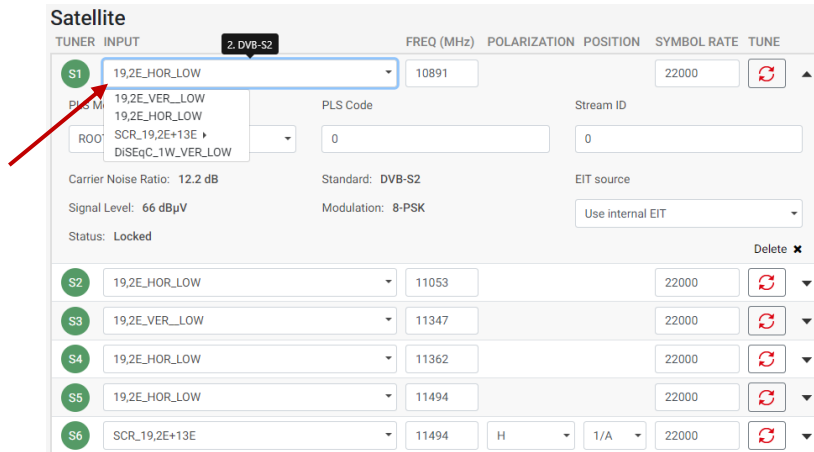

TUNER	INPUT	FREQ (MHz)	POLARIZATION	POSITION	SYMBOL RATE	TUNE
S1	19,2E_HOR_LOW	10891			22000	[Refresh] [Up]
S2	19,2E_HOR_LOW	11053			22000	[Refresh] [Down]
S3	19,2E_VER_LOW	11347			22000	[Refresh] [Down]
S4	19,2E_HOR_LOW	11362			22000	[Refresh] [Down]
S5	19,2E_HOR_LOW	11494			22000	[Refresh] [Down]
S6	SCR_19,2E+13E	11494	H	1/A	22000	[Refresh] [Down]

To select the required input / SAT-IF signal, click on the input field to open the drop-down list with the inputs you can choose from.

Select the input you want to use.

2. Enter the desired frequency in MHz in the frequency field:

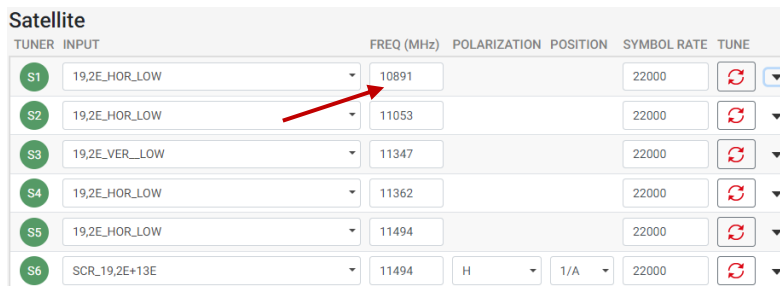

TUNER	INPUT	FREQ (MHz)	POLARIZATION	POSITION	SYMBOL RATE	TUNE
S1	19,2E_HOR_LOW	10891			22000	[Refresh] [Down]
S2	19,2E_HOR_LOW	11053			22000	[Refresh] [Down]
S3	19,2E_VER_LOW	11347			22000	[Refresh] [Down]
S4	19,2E_HOR_LOW	11362			22000	[Refresh] [Down]
S5	19,2E_HOR_LOW	11494			22000	[Refresh] [Down]
S6	SCR_19,2E+13E	11494	H	1/A	22000	[Refresh] [Down]

3. Enter the desired symbol rate:



TUNER	INPUT	FREQ (MHz)	POLARIZATION	POSITION	SYMBOL RATE	TUNE
S1	19,2E_HOR_LOW	10891			22000	[Refresh] [Down]
S2	19,2E_HOR_LOW	11053			22000	[Refresh] [Down]
S3	19,2E_VER_LOW	11347			22000	[Refresh] [Down]
S4	19,2E_HOR_LOW	11362			22000	[Refresh] [Down]
S5	19,2E_HOR_LOW	11494			22000	[Refresh] [Down]
S6	SCR_19,2E+13E	11494	H	1/A	22000	[Refresh] [Down]

- If the input source is DVB-S2X Multistream, expand the tuner settings and enter the PLS Mode, PLS Code and Stream ID.

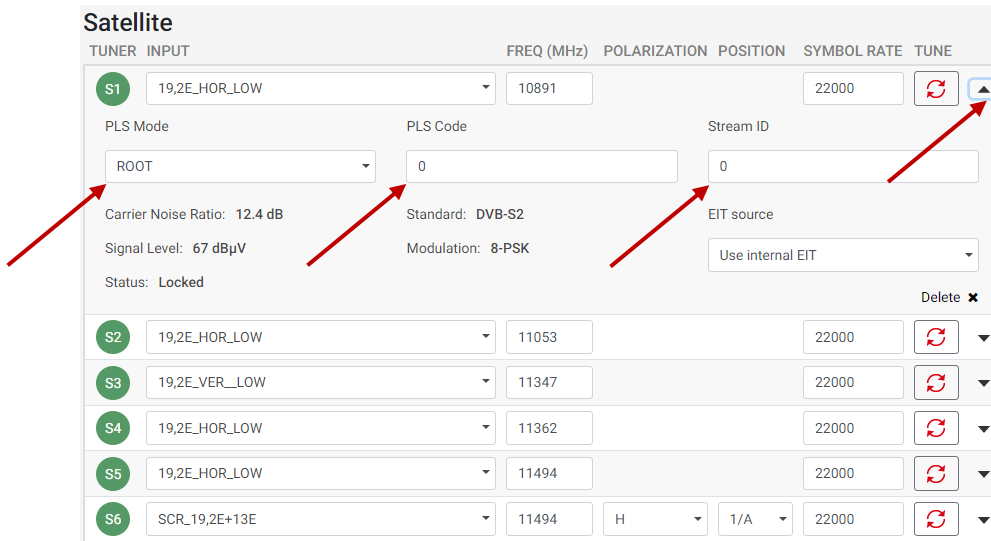

- If the input source is SCR (Satellite Channel Router)

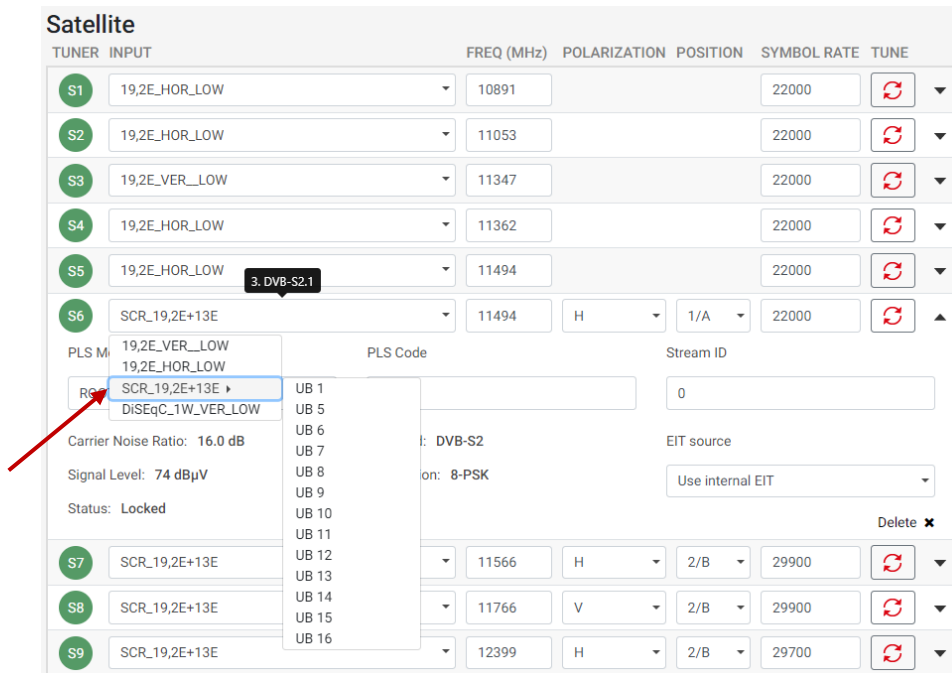

You must select the SCR user band and the Polarisation and Satellite position.

- If an alternative EIT to the internal EIT in the current transport stream, press expand for the tuner and choose the alternative EIT source:

**Satellite**

TUNER	INPUT	FREQ (MHz)	POLARIZATION	POSITION	SYMBOL RATE	TUNE
S1	19,2E_HOR_LOW	10891			22000	
PLS Mode		PLS Code		Stream ID		
ROOT		0		0		
Carrier Noise Ratio: 12.4 dB		Standard: DVB-S2		EIT source		
Signal Level: 67 dBμV		Modulation: 8-PSK		Use internal EIT		
Status: Locked						
Delete						
S2	19,2E_HOR_LOW	11053			22000	
S3	19,2E_VER_LOW	11347			22000	
S4	19,2E_HOR_LOW	11362			22000	
S5	19,2E_HOR_LOW	11494			22000	
S6	SCR_19,2E+13E	11494	H	1/A	22000	













- Click the “TUNE” button to activate the setting into the headend system:

**Satellite**

TUNER	INPUT	FREQ (MHz)	SYMBOL RATE	TUNE
S1	1. DVB-S2	11303	22000	
S2	1. DVB-S2	11273	22000	
S3	1. DVB-S2	11244	22000	
S4	2. DVB-S2	12304	27500	
S5	1. DVB-S2	11494	22000	

By clicking on the expand button, information details from the selected transponder will be shown:

**Satellite**













TUNER	INPUT	FREQ (MHz)	POLARIZATION	POSITION	SYMBOL RATE	TUNE
S1	19,2E_HOR_LOW	10891			22000	 
<p>PLS Mode: ROOT   PLS Code: 0   Stream ID: 0</p> <p>Carrier Noise Ratio: 12.4 dB   Standard: DVB-S2   EIT source: Use internal EIT</p> <p>Signal Level: 67 dBµV   Modulation: 8-PSK</p> <p>Status: Locked</p>						
S2	19,2E_HOR_LOW	11053			22000	 
S3	19,2E_VER_LOW	11347			22000	 
S4	19,2E_HOR_LOW	11362			22000	 
S5	19,2E_HOR_LOW	11494			22000	 
S6	SCR_19,2E+13E	11494	H	1/A	22000	 

- Carrier Noise Ratio: Shows the carrier to noise ratio of the input signal
- Signal Level: Displays the actual signal level
- Standard: Shows the standard of the input signal
- Modulation: Shows the modulation of the input signal
- Status: Shows the status of the tuner



To delete the tuner input, press the “Delete x”:

### Satellite

TUNER	INPUT	FREQ (MHz)	POLARIZATION	POSITION	SYMBOL RATE	TUNE
S1	19,2E_HOR_LOW	10891			22000	 
PLS Mode: <input type="text" value="ROOT"/> PLS Code: <input type="text" value="0"/> Stream ID: <input type="text" value="0"/>		Carrier Noise Ratio: 12.4 dB           Standard: DVB-S2           EIT source: <input type="text" value="Use internal EIT"/>		Signal Level: 67 dBµV           Modulation: 8-PSK           Status: Locked		
S2	19,2E_HOR_LOW	11053			22000	 
S3	19,2E_VER_LOW	11347			22000	 
S4	19,2E_HOR_LOW	11362			22000	 
S5	19,2E_HOR_LOW	11494			22000	 
S6	SCR_19,2E+13E	11494	H	1/A	22000	 

Delete x

A warning will appear:

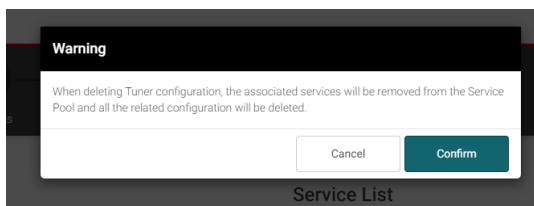

### 5.5.3 Service List

In the Source field, select the tuner number to see available streams with name, type, SID, TSID and ONID:

First Click → sort rising

Second click at same type → sort falling

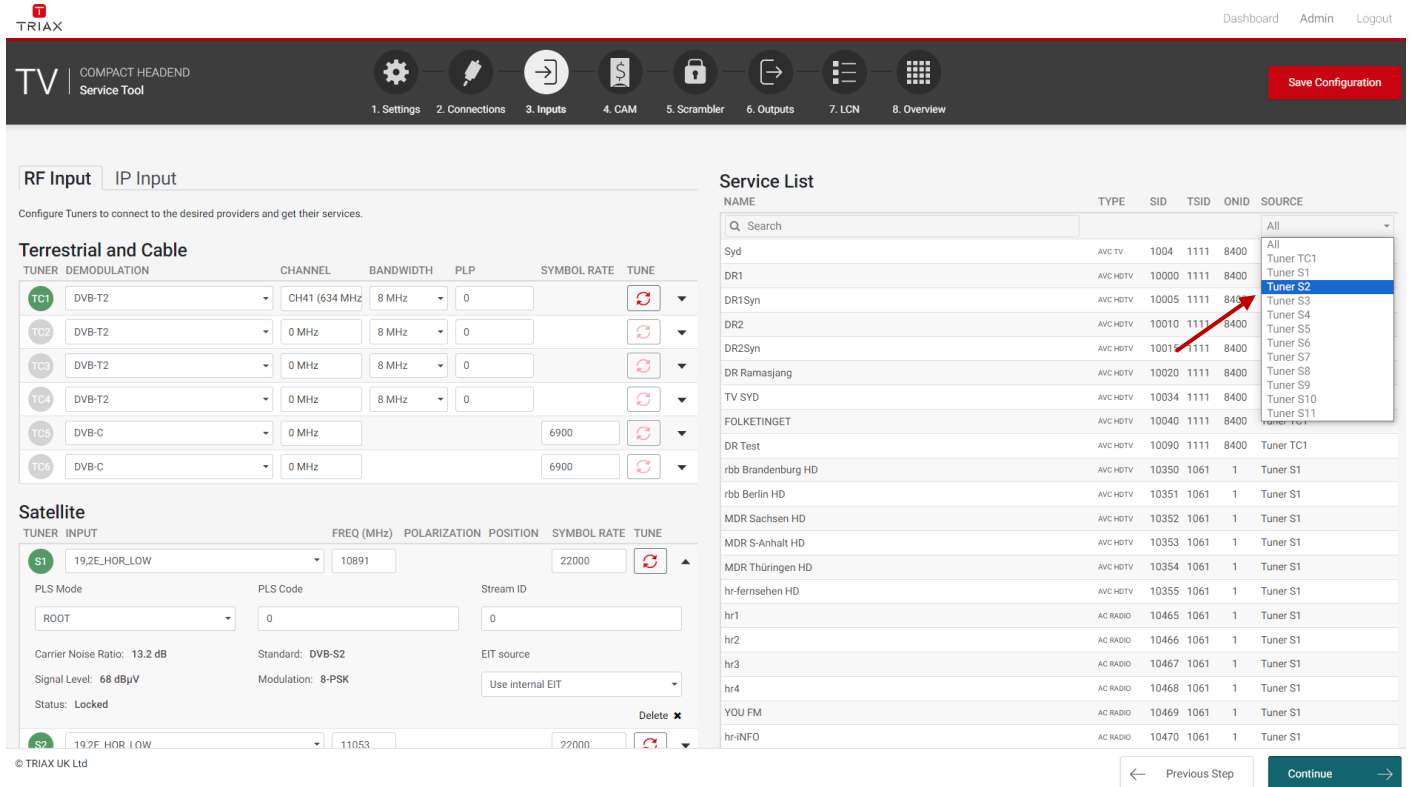

The screenshot shows the TRIAX TV COMPACT HEADEND Service Tool interface. The top navigation bar includes 'Settings', 'Connections', 'Inputs', 'CAM', 'Scrambler', 'Outputs', 'LCN', and 'Overview'. The main area is divided into 'RF Input' and 'IP Input' sections. The 'Terrestrial and Cable' section shows configuration for six tuners (TC1-TC6). The 'Satellite' section shows configuration for two tuners (S1-S2). The 'Service List' table on the right contains the following data:

NAME	TYPE	SID	TSID	ONID	SOURCE
Syd	AVC-TV	1004	1111	8400	All
DR1	AVC-HDTV	10000	1111	8400	Tuner TC1
DR1Syn	AVC-HDTV	10005	1111	8400	Tuner S1
DR2	AVC-HDTV	10010	1111	8400	Tuner S2
DR2Syn	AVC-HDTV	10015	1111	8400	Tuner S3
DR Ramasjang	AVC-HDTV	10020	1111	8400	Tuner S4
TV SYD	AVC-HDTV	10034	1111	8400	Tuner S5
FOLKETINGET	AVC-HDTV	10040	1111	8400	Tuner S6
DR Test	AVC-HDTV	10090	1111	8400	Tuner S7
rbb Brandenburg HD	AVC-HDTV	10350	1061	1	Tuner S8
rbb Berlin HD	AVC-HDTV	10351	1061	1	Tuner S9
MDR Sachsen HD	AVC-HDTV	10352	1061	1	Tuner S10
MDR S-Anhalt HD	AVC-HDTV	10353	1061	1	Tuner S11
MDR Thüringen HD	AVC-HDTV	10354	1061	1	Tuner S1
hr-fernsehen HD	AVC-HDTV	10355	1061	1	Tuner S1
hr1	AC-RADIO	10465	1061	1	Tuner S1
hr2	AC-RADIO	10466	1061	1	Tuner S1
hr3	AC-RADIO	10467	1061	1	Tuner S1
hr4	AC-RADIO	10468	1061	1	Tuner S1
YOU FM	AC-RADIO	10469	1061	1	Tuner S1
hr-INFO	AC-RADIO	10470	1061	1	Tuner S1

Name: Name of the TV or radio service

**Note:**

If you enter a string in the search field of the service name all services which contain the string are listed in the service list.

Type: Audio and video type of service

SID: Service Identifier

TSID: Transport Stream Identifier

ONID: Original Network Identifier

Source: Tuner number where the service is received

## 5.6 IP input

### 5.6.1 Physical connectivity

The TDcH & TDmH headends have 1 IP input for IPTV-in, marked with SFP label, and without a specific colour ring



*Note:*

The TDcH & TDmH headends system must be connected to a Gigabit network switch to receive and deliver IP services. The network switch must support IGMP version 2 / 3 and contain an adequate number of ports.

Cat 5e shielded or better network cables must be used.

**Optional hardware:**

A fibre-optic transceiver can be used instead of an RJ45 SFP transceiver. This is especially relevant for pre-existing optical installations, or for installations with high levels of interference and/or total cable lengths exceeding 100m. The fibre-optic transceiver must be ordered separately.

Item No.:	492086	SFP RJ45
Item No.:	492087	SFP Fiber 850nm EOLS-8512-MXX (500m)
Item No.:	492088	SFP Fiber 1310nm EOLS-1324-02XX (2km)

### 5.6.2 IP-in licenses

IP input licenses need to be purchased from TRIAX to be able to receive IP services through the TDcH & TDmH headend system.

Required license numbers:

Item No.:	418745	TDcH 4 x IP-in streams license
Item No.:	418746	TDcH 16 x IP-in streams license
Item No.:	418747	TDcH 96 x IP-in streams license
Item No.:	418752	TDmH 48 x IP-in streams license
Item No.:	418753	TDmH 16 x IP-in streams license
Item No.:	418754	TDmH 4 x IP-in streams license

Licenses are activated using License handling in the Administration window.

### 5.6.3 Requirements

The headend system includes basic IPTV functionality which enables service delivery over a packet-switched network infrastructure.

To handle IP input through the Link sockets the following requirements must be satisfied:

- IP multicast streaming (UDP streaming)
- Possibility of RTP
- Possibility of IGMP version 2 and version 3
- If no source address is configured, then is IGMPv2 used
- If a source address is configured, then is IGMPv3 used with SSM (Source Specific Multicast)
- SPTS or MPTS including PAT, PMT, CAT, optional SDT

The TDcH & TDmH supports both SPTS and MPTS. With MPTS an inbound stream can contain multiple programmes. The license limits the number of IP-in streams. It does not limit the number of services, thus receiving MPTS can carry more services than the value of the license limit.

**Important:**

The TDcH & TDmH headend system supports up to 7 TS packets per IP packet at the IP input.

The TDcH & TDmH headend system does not support IP fragmentation at the IP input, which may occur if the IP packets are transmitted over a network with a

Maximum Transmission Unit (MTU) less than approximately  $80 + N \cdot 188$  bytes, where N is the number of packets per IP packet..

Recommended settings are 7 TS packets per IP packet and a minimum MTU of 1500 bytes in the entire network path

Licenses for IP output are required to be able to use the IPTV functionality in the headend.  
The licenses can be purchased from TRIAX Sales, and need to be activated, see: "Activating licenses".

### 5.6.4 Configuration in GUI

Receive an IP stream by following the steps below:

- 1) Select the *Inputs* tab in the panes.
- 2) Select the *IP Input* sub-tab.
- 3) Press the New IP input button for a new IP input option.
- 4) Specify the desired IP address and associated UDP port number, and if necessary, the Source address in the corresponding fields.
- 5) Press the Search button  to receive the IP stream
- 6) System will automatically update if EIT detected and the rate [Mbit/s] for the stream plus total rate. By default, the EIT is inside each multicast stream is used.
- 7) An alternative EIT can be configured by selecting the alternative source from the dropdown list among the configured IP inputs multicast addresses.

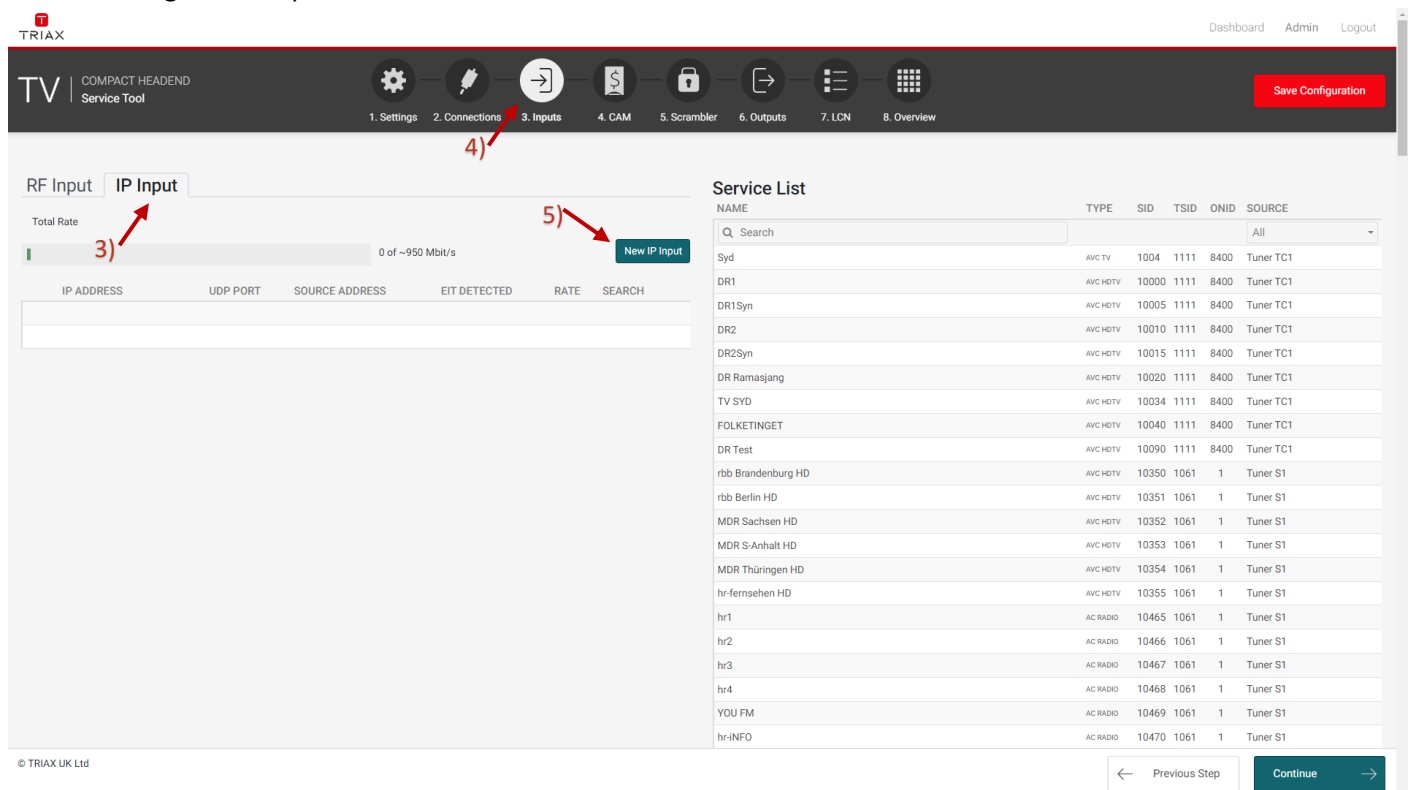

The screenshot shows the TRIAX GUI with the 'Inputs' tab selected. The 'IP Input' sub-tab is active. A red arrow labeled '4)' points to the 'New IP Input' button. Another red arrow labeled '5)' points to the 'New IP Input' button. A third red arrow labeled '3)' points to the 'Total Rate' meter. The 'Service List' table on the right contains the following data:

NAME	TYPE	SID	TSID	ONID	SOURCE
Syd	AVC TV	1004	1111	8400	Tuner TC1
DR1	AVC HDTV	10000	1111	8400	Tuner TC1
DR1Syn	AVC HDTV	10005	1111	8400	Tuner TC1
DR2	AVC HDTV	10010	1111	8400	Tuner TC1
DR2Syn	AVC HDTV	10015	1111	8400	Tuner TC1
DR Ramasjang	AVC HDTV	10020	1111	8400	Tuner TC1
TV SYD	AVC HDTV	10034	1111	8400	Tuner TC1
FOLKETINGET	AVC HDTV	10040	1111	8400	Tuner TC1
DR Test	AVC HDTV	10090	1111	8400	Tuner TC1
rbb Brandenburg HD	AVC HDTV	10350	1061	1	Tuner S1
rbb Berlin HD	AVC HDTV	10351	1061	1	Tuner S1
MDR Sachsen HD	AVC HDTV	10352	1061	1	Tuner S1
MDR S-Anhalt HD	AVC HDTV	10353	1061	1	Tuner S1
MDR Thüringen HD	AVC HDTV	10354	1061	1	Tuner S1
hr-fernsehen HD	AVC HDTV	10355	1061	1	Tuner S1
hr1	AC RADIO	10465	1061	1	Tuner S1
hr2	AC RADIO	10466	1061	1	Tuner S1
hr3	AC RADIO	10467	1061	1	Tuner S1
hr4	AC RADIO	10468	1061	1	Tuner S1
YOU FM	AC RADIO	10469	1061	1	Tuner S1
hr-INFO	AC RADIO	10470	1061	1	Tuner S1

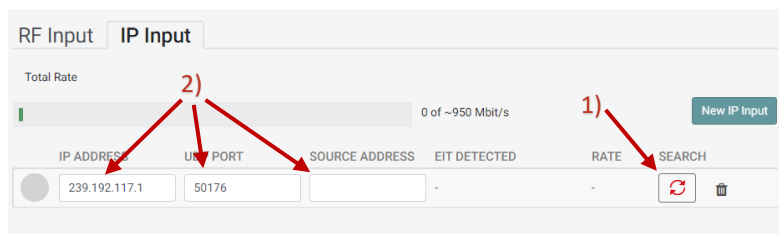

This close-up shows the 'IP Input' configuration form. A red arrow labeled '1)' points to the 'New IP Input' button. Another red arrow labeled '2)' points to the 'UDP PORT' field. The form contains the following fields:

- Total Rate: 0 of ~950 Mbit/s
- IP ADDRESS: 239.192.117.1
- UDP PORT: 50176
- SOURCE ADDRESS: (empty)
- EIT DETECTED: -
- RATE: -
- SEARCH: (Search icon)

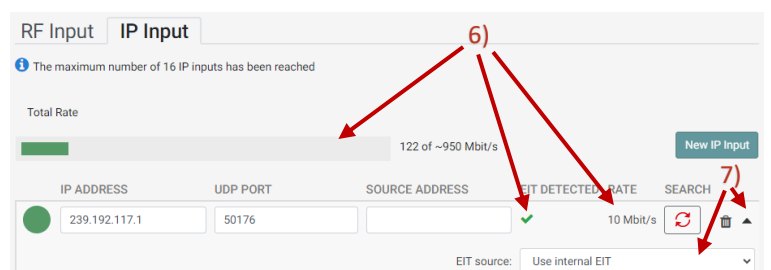

This screenshot shows the 'IP Input' configuration form with a warning message: "The maximum number of 16 IP inputs has been reached". Red arrows labeled '6)' and '7)' point to the 'New IP Input' button and the 'SEARCH' button respectively. The form contains the following fields:

- Total Rate: 122 of ~950 Mbit/s
- IP ADDRESS: 239.192.117.1
- UDP PORT: 50176
- SOURCE ADDRESS: (empty)
- EIT DETECTED: (checked)
- RATE: 10 Mbit/s
- SEARCH: (Search icon)
- EIT source: Use internal EIT

Previously selected services can be refreshed when pressing the Search/Refresh button  
 Previously selected services can be deleted when pressing the Bin button

The screenshot shows the TRIAX TV COMPACT HEADEND Service Tool interface. The 'IP Input' tab is selected, displaying a table of IP addresses and their rates. The 'Service List' is also visible, with a dropdown menu for 'SOURCE' set to 'IP-in'. Red arrows point to the 'SOURCE' dropdown and the 'IP-in' option. A 'Continue' button is at the bottom right.

IP ADDRESS	UDP PORT	SOURCE ADDRESS	EIT DETECTED	RATE	SEARCH
239.192.117.1	50176		✓	8 Mbit/s	
239.192.117.2	50176		✓	11 Mbit/s	
239.192.117.3	50176		✓	9 Mbit/s	
239.192.117.7	50176		✓	7 Mbit/s	
239.192.117.8	50176		✓	7 Mbit/s	
239.192.117.9	50176		✓	4 Mbit/s	
239.192.117.10	50176		✓	7 Mbit/s	
239.192.117.11	50176		✓	12 Mbit/s	
239.192.117.12	50176		✓	15 Mbit/s	
239.192.117.38	50176		✓	6 Mbit/s	
239.192.117.39	50176		✓	6 Mbit/s	

NAME	TYPE	SID	TSID	UNID	SOURCE
HSE Extra HD	AVC HDTV	5501	108	117	IP-in
1-2-3.tv HD	AVC HDTV	5502	109	117	IP-in
QVC ZWEI HD	AVC HDTV	5504	110	117	Tuner TC1
tagesschau24 HD	AVC HDTV	10375	114	117	Tuner TC2
ONE HD	AVC HDTV	10376	115	117	Tuner TC3
ARD alpha HD	AVC HDTV	10377	116	117	Tuner TC4
SR Fernsehen HD	AVC HDTV	10378	117	117	Tuner TC5
rbb Berlin HD	AVC HDTV	10351	11	117	Tuner S1
MDR Sachsen HD	AVC HDTV	10352	12	117	Tuner S2
3sat	MPEG2 TV	28007	38	117	Tuner S3
KIKA	MPEG2 TV	28008	39	117	Tuner S4
ZDF	MPEG2 TV	28006	40	117	Tuner S5
zdf_neo	MPEG2 TV	28014	41	117	Tuner S6
ZDFinfo	MPEG2 TV	28011	42	117	239.192.117.2:50176
ARD alpha HD	AVC HDTV	10377	103	117	239.192.117.3:50176
SR Fernsehen HD	AVC HDTV	10378	104	117	239.192.117.7:50176
					239.192.117.8:50176
					239.192.117.9:50176
					239.192.117.10:50176
					239.192.117.41:50176
					239.192.117.42:50176
					239.192.117.94:50176
					239.192.117.95:50176

### List of found services

On the right hand in the GUI in the *Service List* you can filter the available services to display only the IP-in services. To highlight/sort the services received via "IP Input" select "IP-in" under "SOURCE" at the *Service List*. To see services from a specific IP-in stream select the actual Multicast address e.g. 239.192.117.1:50176.

## 5.7 CAM

**Note:**

This functionality is not available on the FTA Versions TDcH 16S-Q, TDcH 16S, TDmH IP, and TDmH S8.

Click the “CAM” tab in the TDcH & TDmH Service Tool to display the CA Modules and administration window.

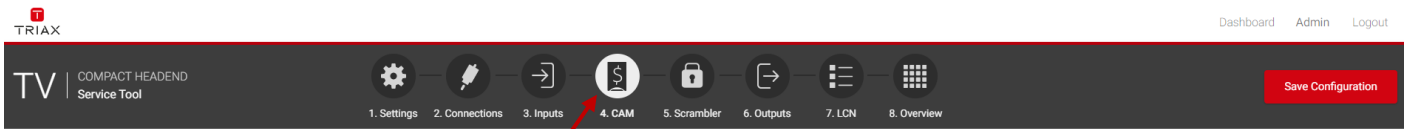

The first time you display the CAM window in a new configuration the module list only displays the number and type of the CA modules that you have inserted in the TDcH & TDmH.

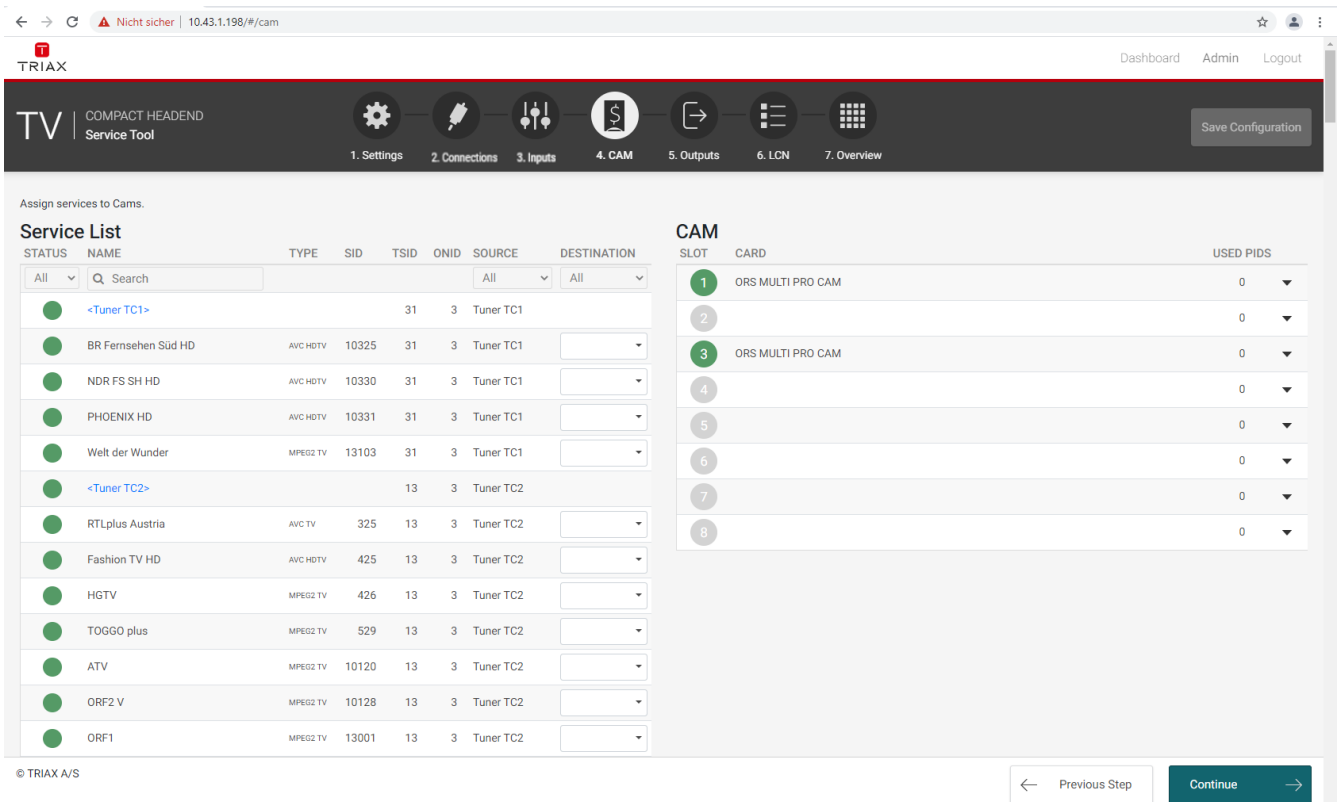

You must configure the CA modules individually. When you open the Configuration window for a CA module in a new configuration, only default values are displayed.

### 5.7.1 CAM / Smart card

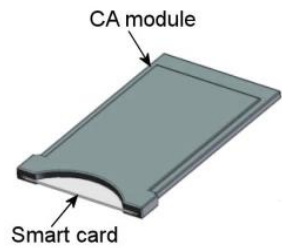
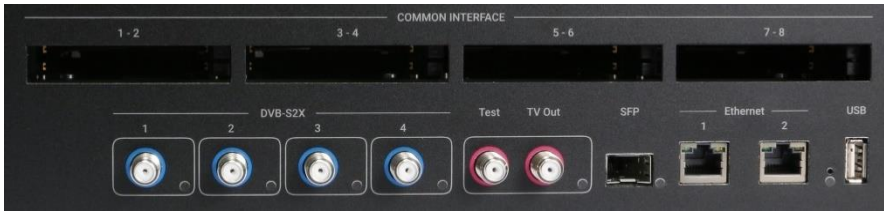

You can insert 4 or 8 Conditional Access Modules (CAM) into a TDmH & TDch Headends

Each CA module can unscramble at least one service. The amount of services and which services depend on the service provider of the CA module and smart card.

### 5.7.2 CAM configuration

At the first step you must assign to a CA module the services the CA module should handle. To assign the services open the drop-down menu under SOURCE and choose the tuner you would like to select services for a CA module.

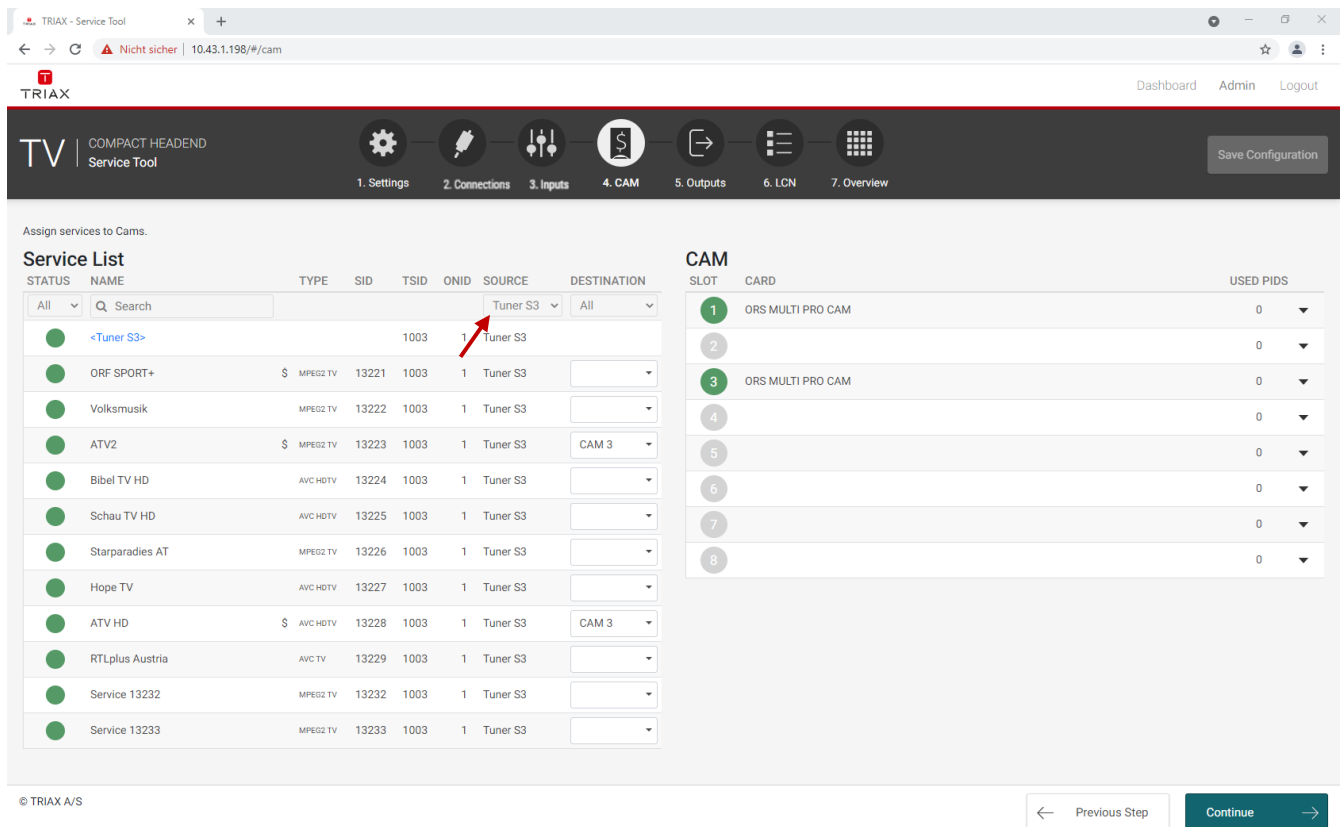

Assign services to Cams.

Service List							
STATUS	NAME	TYPE	SID	TSID	ONID	SOURCE	DESTINATION
All	Q Search					Tuner S3	All
●	<Tuner S3>			1003	1	Tuner S3	
●	ORF SPORT+	\$ MPEG2 TV	13221	1003	1	Tuner S3	
●	Volksmusik	MPEG2 TV	13222	1003	1	Tuner S3	
●	ATV2	\$ MPEG2 TV	13223	1003	1	Tuner S3	CAM 3
●	Bibel TV HD	AVC HDTV	13224	1003	1	Tuner S3	
●	Schau TV HD	AVC HDTV	13225	1003	1	Tuner S3	
●	Starparadies AT	MPEG2 TV	13226	1003	1	Tuner S3	
●	Hope TV	AVC HDTV	13227	1003	1	Tuner S3	
●	ATV HD	\$ AVC HDTV	13228	1003	1	Tuner S3	CAM 3
●	RTLplus Austria	AVC TV	13229	1003	1	Tuner S3	
●	Service 13232	MPEG2 TV	13232	1003	1	Tuner S3	
●	Service 13233	MPEG2 TV	13233	1003	1	Tuner S3	

CAM		
SLOT	CARD	USED PIDS
1	ORS MULTI PRO CAM	0
2		0
3	ORS MULTI PRO CAM	0
4		0
5		0
6		0
7		0
8		0

© TRIAX A/S

← Previous Step    Continue →



In the DESTINATION column you can now choose the services you would like to send to a CA module.

**Note:**

It is possible to send services from different transponders to the same CA modules, so that the number of CA modules can be reduced.

Please do not overload the CA module with services and please ensure that the supported amount of PIDs is not overloaded.

The supplier of the CA module can inform you about how many PIDs the CA module can support.

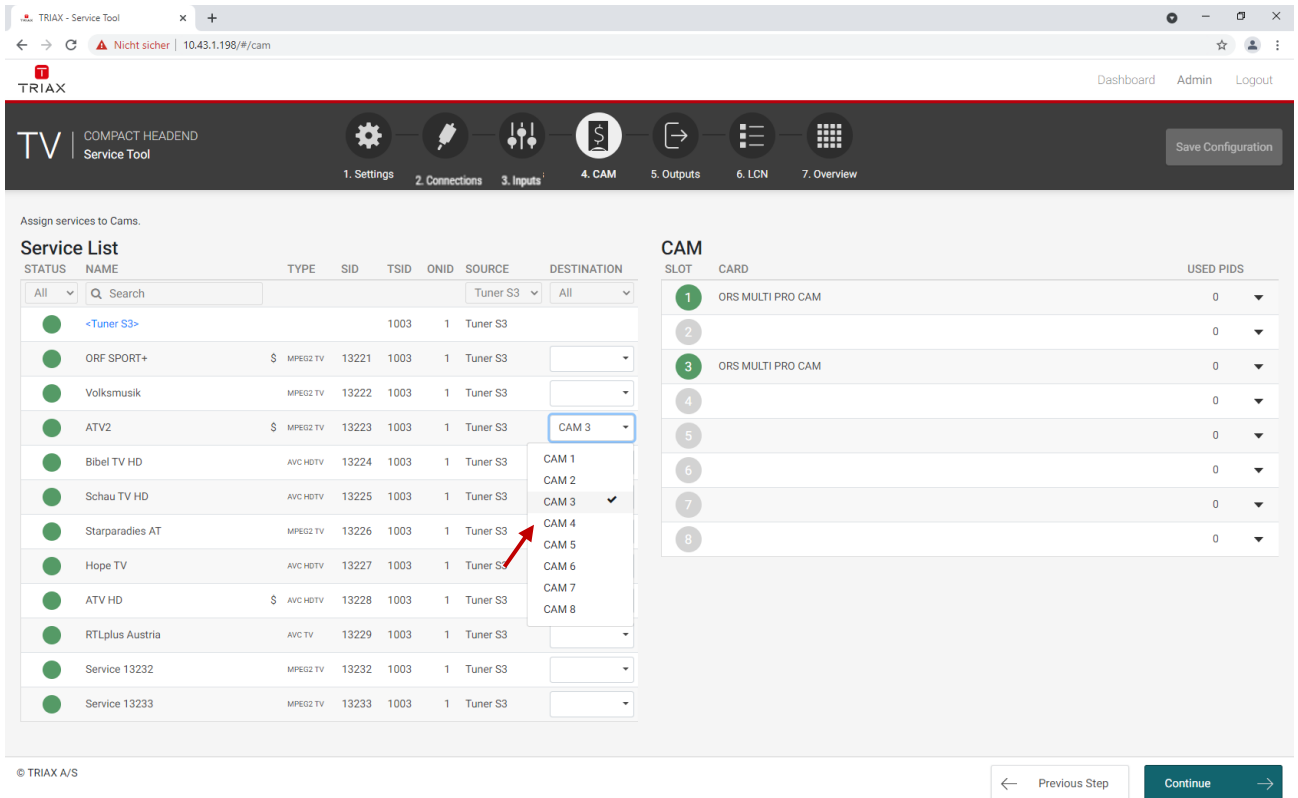

By clicking the expand button on the CA menu the detailed configuration menu opens.

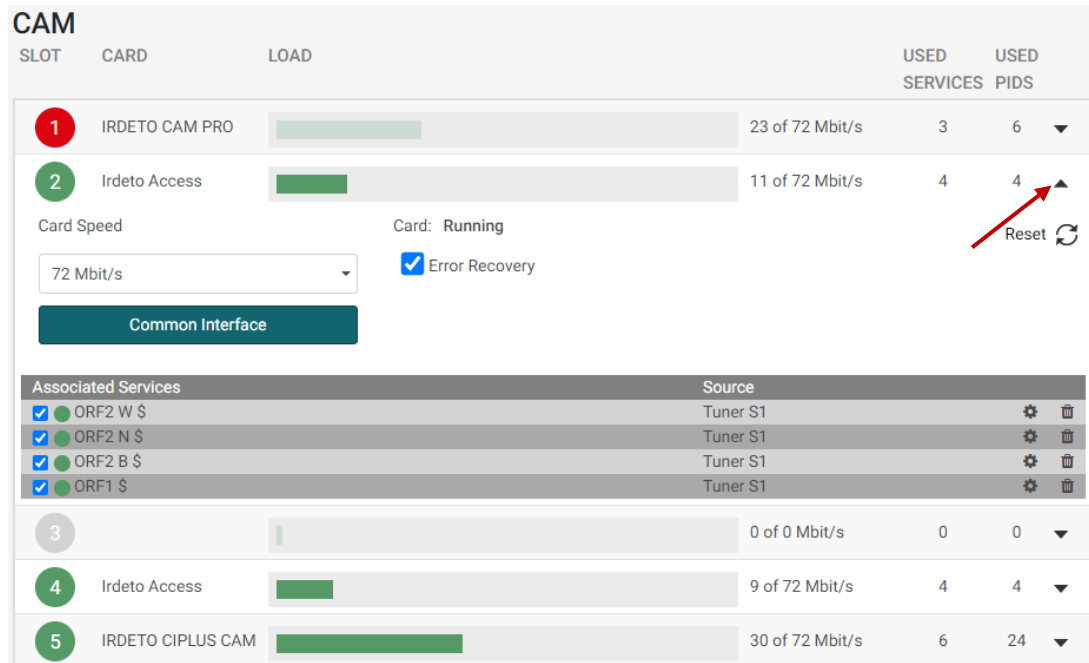

**Card speed:**

Open the drop-down list with the card speeds if you want to use a higher card speed than the default. Select the required card speed.

**Load:**

The load shows current used payload and how much is free of the accessible payload. Transport stream packages are dropped if the load bar turns red, in which case the amount of associated services must be reduced.

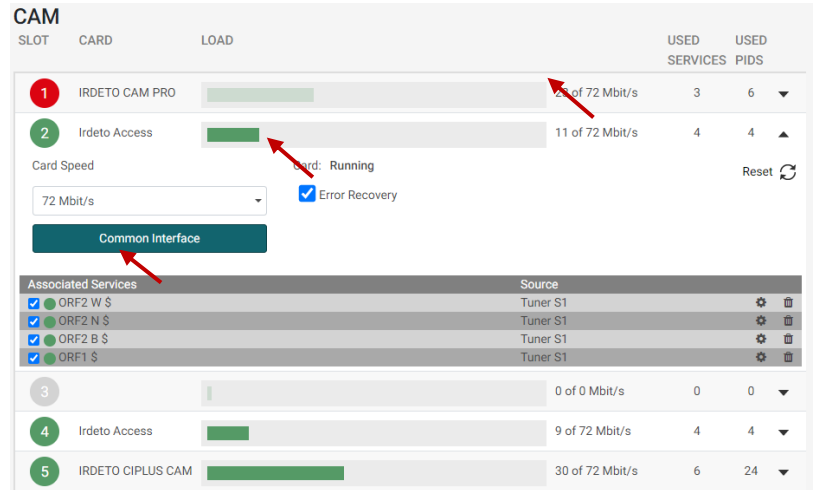

**Service list area (Associated Services)**

Select the service(s) you want to descramble in the Service list area by clicking the service(s) at the selected button. Scrambled services are marked with a dollar sign - \$.

**Note:**

Please note that the services in the CAM menu have to be assigned with the check box to be descrambled!

**Used PIDs:**

This number shows how many PIDs the CAM is using for descrambling the TV services.

Please ensure that the CA module is not overloaded with used PIDs. The numbers of PIDs a CA-module can support depends on CA module. Please ask the CAM supplier or the program operator if you are unsure how many PIDs the CA module can support.

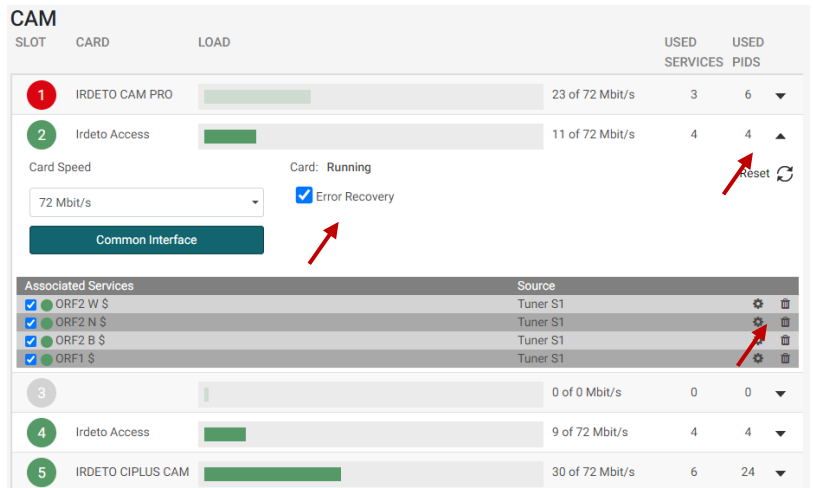

**Error Recovery**

If you select the “Error Recovery” checkbox then the automatic error recovery is enabled for all services assigned to this CA-module.

**Note:**

The Error Recovery function does a constant monitoring of the signal transmission status through the CA module. The CA module is automatically reset if the signal transmission fails. When a CA module is reset, the signal transmission is interrupted for all the services associated with that CA module. The “Error Recovery” checkbox should not be enabled for services where signals are not transmitted on a 24-hour basis.

**Filter options**

To change the Filter options for a service, click the Setup button of the service in question to open the Filter options window.

To descramble all PIDs that are not audio or video related, click the “Descramble non audio/video” PIDs checkbox.

By default, all audio PIDs (Packet Identifier) associated with the service are descrambled.

To descramble only selected audio PIDs you must deselect the Descramble all audio PIDs checkbox. Deselecting the Descramble all audio PIDs checkbox displays a field with a drop-down list below the checkbox.

Open the drop-down list and select the language of the audio PID you want to descramble.

An additional field with a language drop-down list is displayed every time you select a language. You can descramble as many audio PIDs as you need.

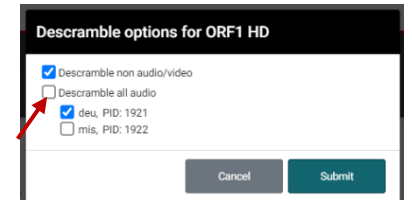
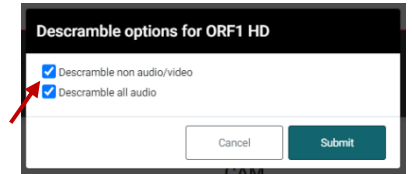

### 5.7.3 Common interface

Clicking the Common interface button gives you access to information from the smart card inserted in the CA module. The type of information provided by the smart card depends on the card itself and its make.

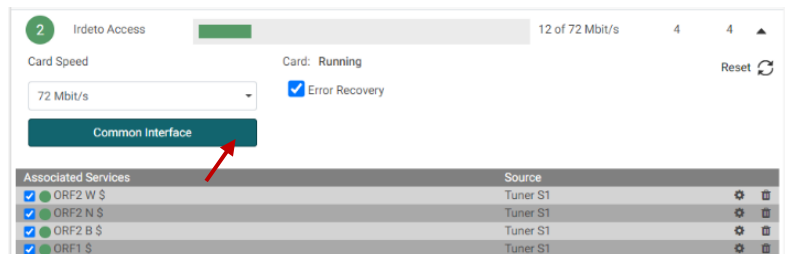

Please refer to the user guides of the CA modules and smart cards you have inserted for further information.

### 5.7.4 Reset CAM

If the CA module malfunctions, click the Reset CAM button to reboot the CA module. When a CA module is reset, the signal transmission is interrupted for all the services associated with that CA module.

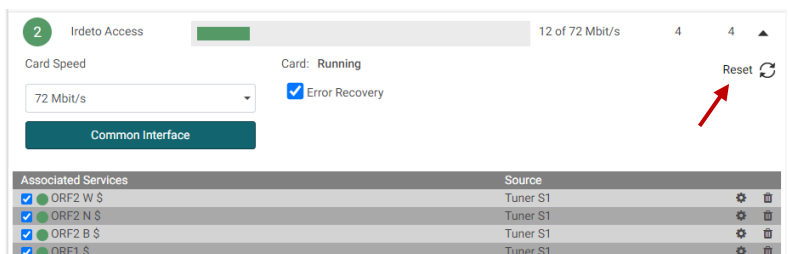

## 5.8 RF Outputs

The Output Tab is for assigning services to the RF output channels and to the IPTV addresses.

*Note:*

In most models the output modulation can be changed between QAM and COFDM. Select the required output modulation before you start to configure the TDcH & TDmH.

For changing the output modulation, please see 5.3.6 Output Modulation.

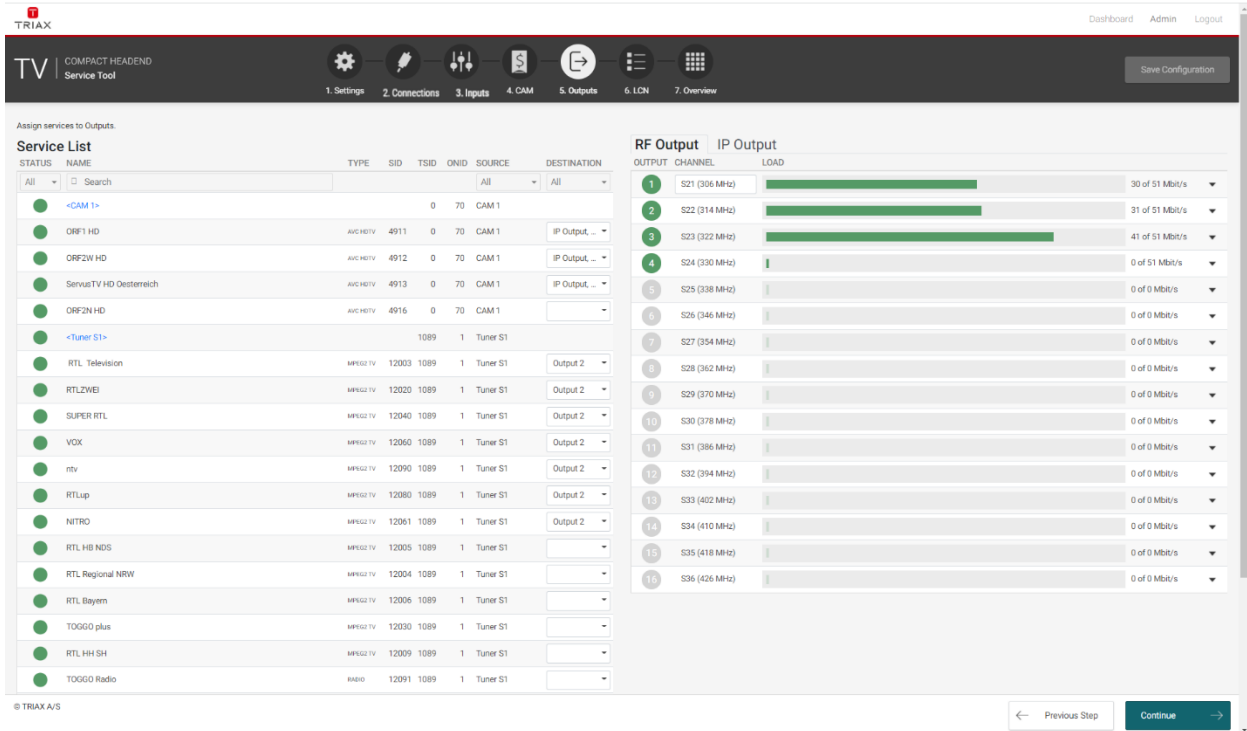

The first time the Service Tool displays the configuration window for the output in a new configuration, the fields in the window will display default values and/or be empty, and the output will be disabled.

### Channel plan:

Before starting the Output configuration please be sure that the channel plan is set in the Settings folder!

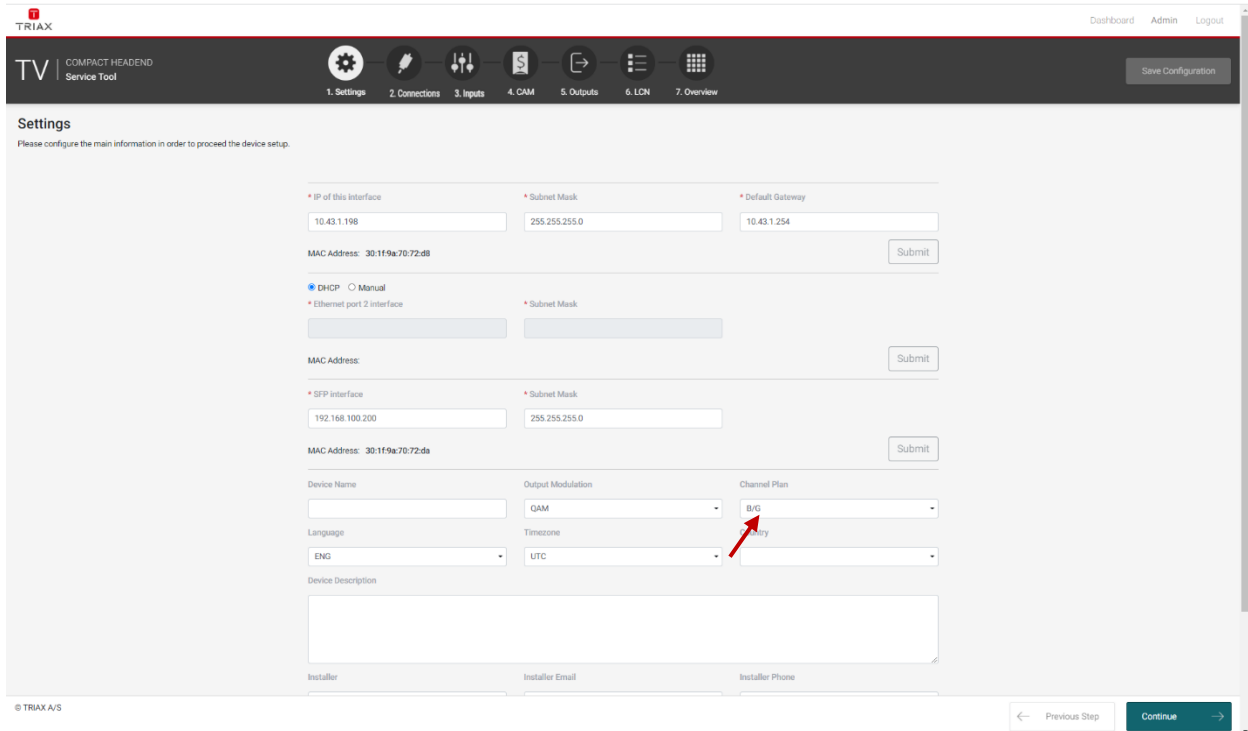

**Select service:**

*Note:*

Services can be assigned to an output channel in direct conversion or as a new multiplex. In the direct conversion a full input transponder is assigned to an output channel. If a new multiplex is made, single services can be chosen from independent input transponders.

**Direct channel conversion / Transparent mode:**

Select under DESTINATION for each Input the output you would like to use the direct conversion function.

*Note:*

All services below this input will be shown as assigned to the selected outputs and cannot be used for other outputs!

Please note that services allocated in direct conversion to an output are not shown in the LCN table. Only services allocated in new multiplexes are shown in the LCN list!

Service List							
STATUS	NAME	TYPE	SID	TSID	ONID	SOURCE	DESTINATION
All	Q Search					All	All
●	<Tuner TC1>			31	3	Tuner TC1	Output 1
●	BR Fernsehen Süd HD	AVC HDTV	10325	31	3	Tuner TC1	Output 1 ✓
●	NDR FS SH HD	AVC HDTV	10330	31	3	Tuner TC1	Output 2
●	PHOENIX HD	AVC HDTV	10331	31	3	Tuner TC1	Output 3
●	Welt der Wunder	MPEG2 TV	13103	31	3	Tuner TC1	Output 4
●	<Tuner S1>			1007	1	Tuner S1	Output 5
●	ORF1 HD	AVC HDTV	4911	1007	1	Tuner S1	Output 6
●	ORF2W HD	AVC HDTV	4912	1007	1	Tuner S1	Output 7
●	ServusTV HD Osterreich	AVC HDTV	4913	1007	1	Tuner S1	Output 8
●	ServusTV HD Deutschland	AVC HDTV	4914	1007	1	Tuner S1	Output 9
●	ORF2N HD	AVC HDTV	4916	1007	1	Tuner S1	Output 10
●	OE3.	RADIO	4920	1007	1	Tuner S1	Output 11
							Output 12
							Output 13
							Output 14
							Output 15
							Output 16

**New multiplex / Service mode:**

If you would like to make a new output multiplex you can select individual services from different inputs for each output.

*Note:*

Please ensure that in both variations the output bandwidth is not overloaded!

### 5.8.1 QAM Modulation

#### Enable All RF Outputs

You can quickly enable or disable all RF outputs by this setting.

#### QAM output frequency:

You can configure a QAM output frequency by using the specifications of the channel plan or by entering a frequency manually.

#### Using the channel plan definitions:

Open the drop-down list with the predefined channels and select the channel you want to use.

#### Note:

The Channel is only needed for Output 1 – all others are set automatically!

#### Enter a frequency manually:

Click into the frequency field and enter the frequency directly. Enter the desired frequency in MHz in the Frequency field.

#### Note:

The Channel is only needed for Output 1 all others are set automatically!

RF Output		IP Output
OUTPUT	CHANNEL	LOAD
1	S21 (306 MHz)	32 of 51 Mbit/s
2	S21 (306 MHz)	37 of 51 Mbit/s
3	S22 (314 MHz)	33 of 51 Mbit/s
4	S23 (322 MHz)	39 of 51 Mbit/s
5	S24 (330 MHz)	31 of 51 Mbit/s
6	S25 (338 MHz)	41 of 51 Mbit/s
7	S26 (346 MHz)	44 of 51 Mbit/s
8	S27 (354 MHz)	1 of 51 Mbit/s
9	S28 (362 MHz)	37 of 51 Mbit/s
10	S29 (370 MHz)	7 of 51 Mbit/s
11	S26 (346 MHz)	33 of 51 Mbit/s
12	S30 (378 MHz)	0 of 51 Mbit/s
13	S31 (386 MHz)	0 of 51 Mbit/s
14	S32 (394 MHz)	0 of 51 Mbit/s
15	S33 (402 MHz)	0 of 51 Mbit/s
16	S34 (410 MHz)	0 of 51 Mbit/s
	S35 (418 MHz)	0 of 51 Mbit/s
	S36 (426 MHz)	41 of 51 Mbit/s

Open the detailed output configuration menu with the extend button.

**Constellation:**

To select which QAM mode to use, open the dropdown list and select the QAM mode you want to use.

**Symbol rate:**

Enter the desired symbol rate (from 3150 to 7200 kS) in the Symbol rate field.

**Level correction:**

RF output level correction can be set in the first output channel for all output channels between 0 and -16 dB.

**Enable Output:**

If you want to enable this channel, click the Enable Output checkbox.

*Note:*

If the output is disabled, then there will be no transport stream or carrier present at this output. The services selected for this output will still be seen as configured in the system. The information about the services at this output will still exist via EIT\_other, SDT\_other and NIT\_other!

**LOAD monitor**

The payload monitor is a real time monitor, which visually indicates the amount of data currently being transmitted.

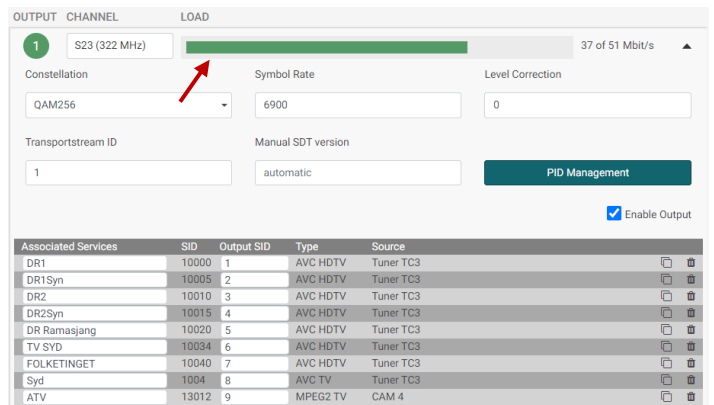
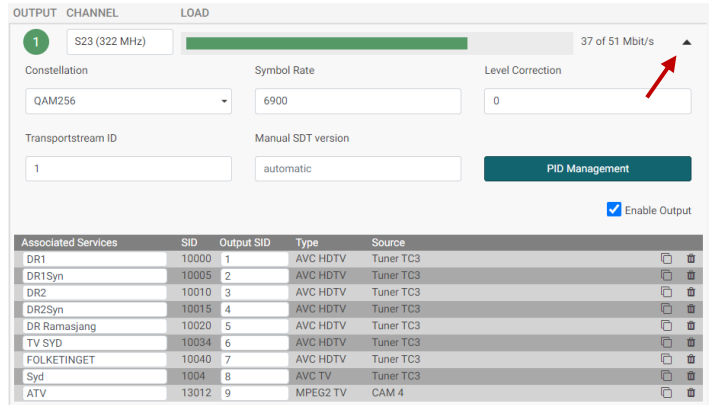

## 5.8.2 COFDM Modulation

### CHANNEL

You can configure a COFDM output frequency by using the specifications of the channel plan or by entering a frequency manually.

#### Using the channel plan definitions:

Open the drop-down list with the predefined channels and select the channel you want to use.

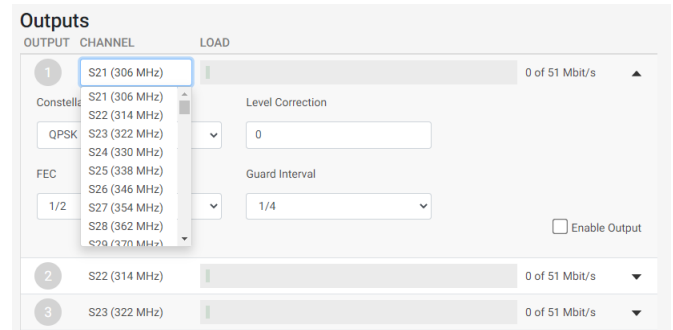

#### Note:

The Channel is only needed for Output 1 – all others are set automatically!

#### Enter a frequency manually:

Click into the frequency field and enter the frequency directly. Enter the desired frequency in MHz in the Frequency field.

#### Note:

The Channel is only needed for Output 1, all others are set automatically!

### Constellation

To select which transmission mode to use, click the arrow to the right of the Transmission mode field to open the drop-down list with the modes you can choose from.

Select the transmission mode you want to use.

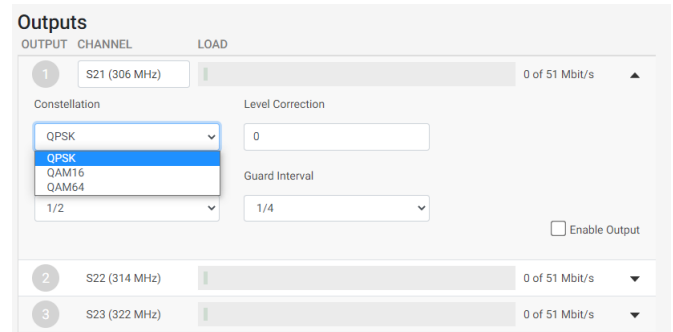

### Level Correction:

RF output level correction can be set in the first output channel for all output channels between 0 and -16 dB.

### FEC

To select which FEC rate to use, click the arrow to the right of the FEC field to open the drop-down list with the FEC rates you can choose from.

Select the FEC rate you want to use.

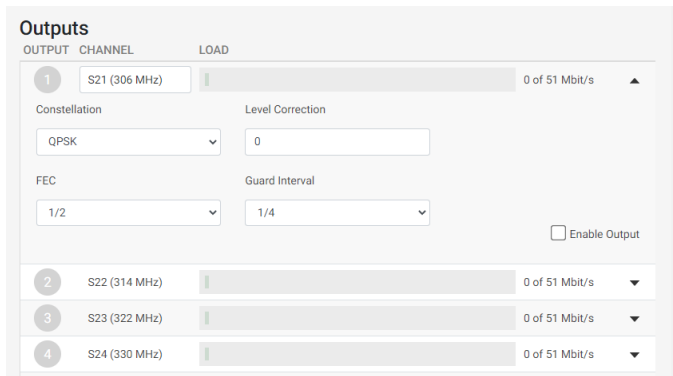

### Guard Interval

To select which guard interval to use, click the arrow to the right of the Guard interval field to open the dropdown list with the intervals you can choose from.

Select the guard interval you want to use.



**Enable Output:**

If you want to enable this channel, click the Enable Output checkbox.

**LOAD monitor**

The payload monitor is a real time monitor, which visually indicates the amount of data that is currently being transmitted.

**5.8.3 TSID and SID Management – RF Output**

**Manual SDT version**

The SDT version will stay fixed to the configured value if the “Manual SDT version” is set.

The SDT version will automatically be increased by one if this configuration is not set and other configuration changes affect the SDT.

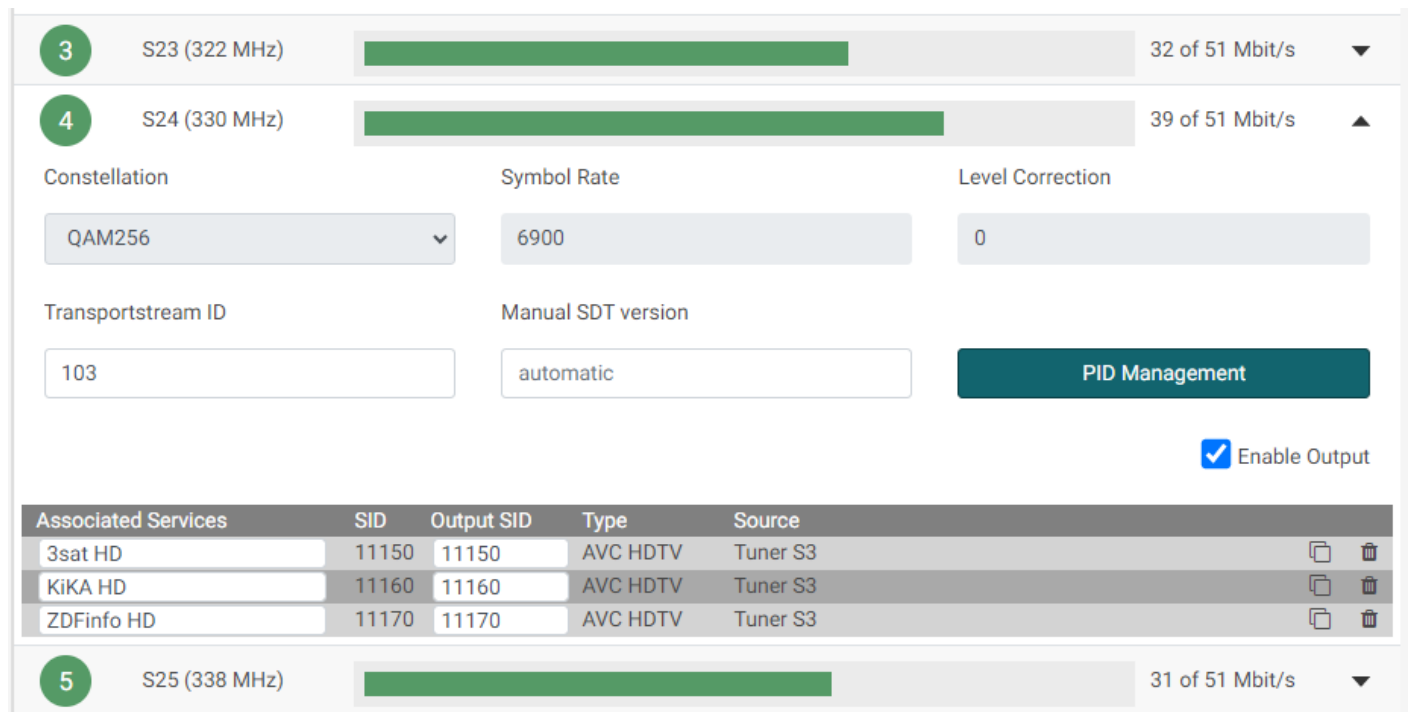

The screenshot displays the configuration interface for three channels: S23 (322 MHz), S24 (330 MHz), and S25 (338 MHz). Channel S24 is currently selected and expanded to show detailed settings. The settings include a Constellation of QAM256, a Symbol Rate of 6900, and a Level Correction of 0. The Transportstream ID is set to 103, and the Manual SDT version is set to automatic. A 'PID Management' button is present, and the 'Enable Output' checkbox is checked. Below the settings is a table of associated services:

Associated Services	SID	Output SID	Type	Source
3sat HD	11150	11150	AVC HDTV	Tuner S3
KIKA HD	11160	11160	AVC HDTV	Tuner S3
ZDFinfo HD	11170	11170	AVC HDTV	Tuner S3

**Transport stream ID**

In the field Transport stream ID you will find the actual used Transport stream ID.

If you would like to change this you can type a new value into the field.

*Note:*

If there is a conflict with another Transport stream using the same ID, the field and the ID number will have a red indication!

**Output SID**

In the field Output SID you will find the actual used Output SID.

If you would like to change this, you can type a new value into the field.

*Note:*

If there is a conflict with another Output using the same ID, the field and the ID number will have a red indication!

### 5.8.4 PID Management – RF Output

Pressing the PID Management button opens the PID management menu.

In PID Management window you will find the following information:

- Service Name
- Output SID
- Stream Type
- Details like CAS ID, Audio type, etc.
- Original PID
- Selected YES/NO
- Conflicts
- FIXED PID
- Output PID

#### Filter PID's

By deselecting the filter check box you can deselect (filter) PID's.

This can be used if you would like to reduce audio or other information from the service.

#### Fixed PID

If you enter a PID in the "FIXED PID" field the PID will be changed to this setting.

#### Note:

If a PID is used twice there will be an error indication shown and the PID with the same value will be highlighted.

SERVICE	OUTPUT SID	STREAM TYPE	DETAILS	ORIGINAL PID	SELECTED	CONFLICT	FIXED PID	OUTPUT PID
ORF1 HD	4911	PMT		107				107
ORF1 HD	4911	ECM	CAS ID: 1608	120	<input checked="" type="checkbox"/>	▲	122	120
ORF1 HD	4911	ECM	CAS ID: 1616	122	<input checked="" type="checkbox"/>	▲		122
ORF1 HD	4911	ECM	CAS ID: 3477	270	<input checked="" type="checkbox"/>			270
ORF1 HD	4911	ECM	CAS ID: 3480	272	<input checked="" type="checkbox"/>			272
ORF1 HD	4911	ECM	CAS ID: 1762	320	<input checked="" type="checkbox"/>			320
ORF1 HD	4911	ECM	CAS ID: 1280	461	<input checked="" type="checkbox"/>			461
ORF1 HD	4911	ECM	CAS ID: 2445	470	<input checked="" type="checkbox"/>			470
ORF1 HD	4911	ECM	CAS ID: 2500	480	<input checked="" type="checkbox"/>			480
ORF1 HD	4911	ECM	CAS ID: 2444	490	<input checked="" type="checkbox"/>			490
ORF1 HD	4911	H264 Video (PCR)	AVC	1920	<input checked="" type="checkbox"/>			1920
ORF1 HD	4911	Private data	deu, AC3	1921	<input checked="" type="checkbox"/>			1921
ORF1 HD	4911	Private data	mis, AC3	1922	<input checked="" type="checkbox"/>			1922
ORF1 HD	4911	Teletext		1925	<input checked="" type="checkbox"/>			1925
ORF1 HD	4911	Teletext		1925	<input checked="" type="checkbox"/>			1925

Close

### 5.8.5 Multiple services – RF Output

The TDcH & TDmH support sending out services multiple times.

This functionality can be used to send out the service with different audio languages.

This has the advantage that the services are available multiple times in the service list, so the customer can choose the service with the desired audio language by simply changing the channel. They do not have to use the audio function of the television.

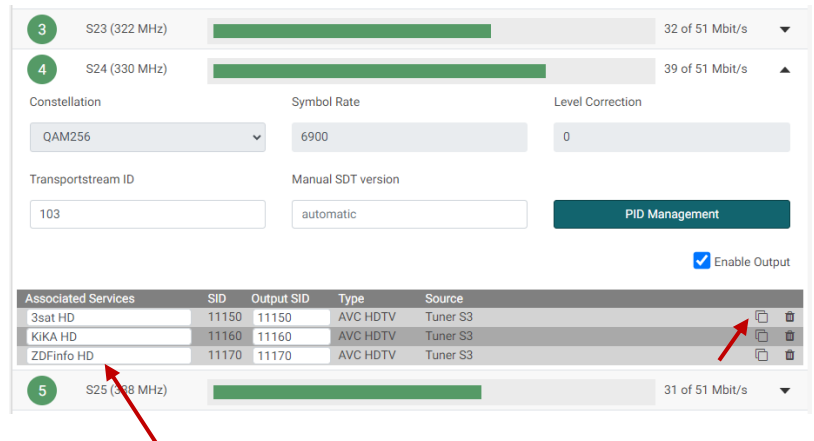

With this function it is also possible to make language packages in the channel plan so the services with the same languages are in one block in the channel list.

If you press the copy button the service will be added as a copy.

*Note:*

The common elements will only exist once in the stream, so this is not a one-to-one increase in the payload! Payload is only effected by the extra PMT and different elements like different audio languages.

### 5.8.6 Rename services – RF Output

The service name for any service, like a duplicated service, can be renamed. A service is renamed via the field below Associated Services.

### 5.8.7 Configure service type – RF Output

If the service is originating from a stream without SDT from an IP-input, then the service type will be unknown due to the missing SDT. The missing SDT will result in the service name being shown as “Unknown” in the *Type* field and it is possible to configure it. If you are in doubt then set the type to “MPEG 2 TV” for a TV service and “Radio” for a radio service.

## 5.9 IP Output

### 5.10 License

IP output licenses need to be purchased from TRIAX to enable the distribution of IP services through the TDcH & TDmH headend system.

Required license numbers:

Item No.:	418740	TDcH IP-out license
Item No.:	418751	TDmH IP-out 48 license

Licenses are activated using License handling in the Administration window.

### 5.11 Requirements

The TDcH & TDmH streams Multicast UPD/RTP SPTS streams out with 7 transport streams packets per IP packet.

*Note:*

The TDcH & TDmH headends system must be connected to a Gigabit network switch to receive and deliver IP services. The network switch must support IGMP version 2 / 3 and contain an adequate number of ports.

Cat 5e shielded or better network cables must be used.

### 5.12 Hardware

**Optional hardware:**

A fibre-optic transceiver can be used instead of an RJ45 SFP transceiver. This is especially relevant for pre-existing optical installations, or for installations with high levels of interference and/or total cable lengths exceeding 100m. The fibre-optic transceiver must be ordered separately.

Item No.:	492086	SFP RJ45
Item No.:	492087	SFP Fiber 850nm EOLS-8512-MXX (500m)
Item No.:	492088	SFP Fiber 1310nm EOLS-1324-02XX (2km)

### 5.13 IPTV out configuration in GUI

Enter the configuration for IPTV out in the GUI by entering the *Output* tab in the panes and the *IP Output* sub-tab.

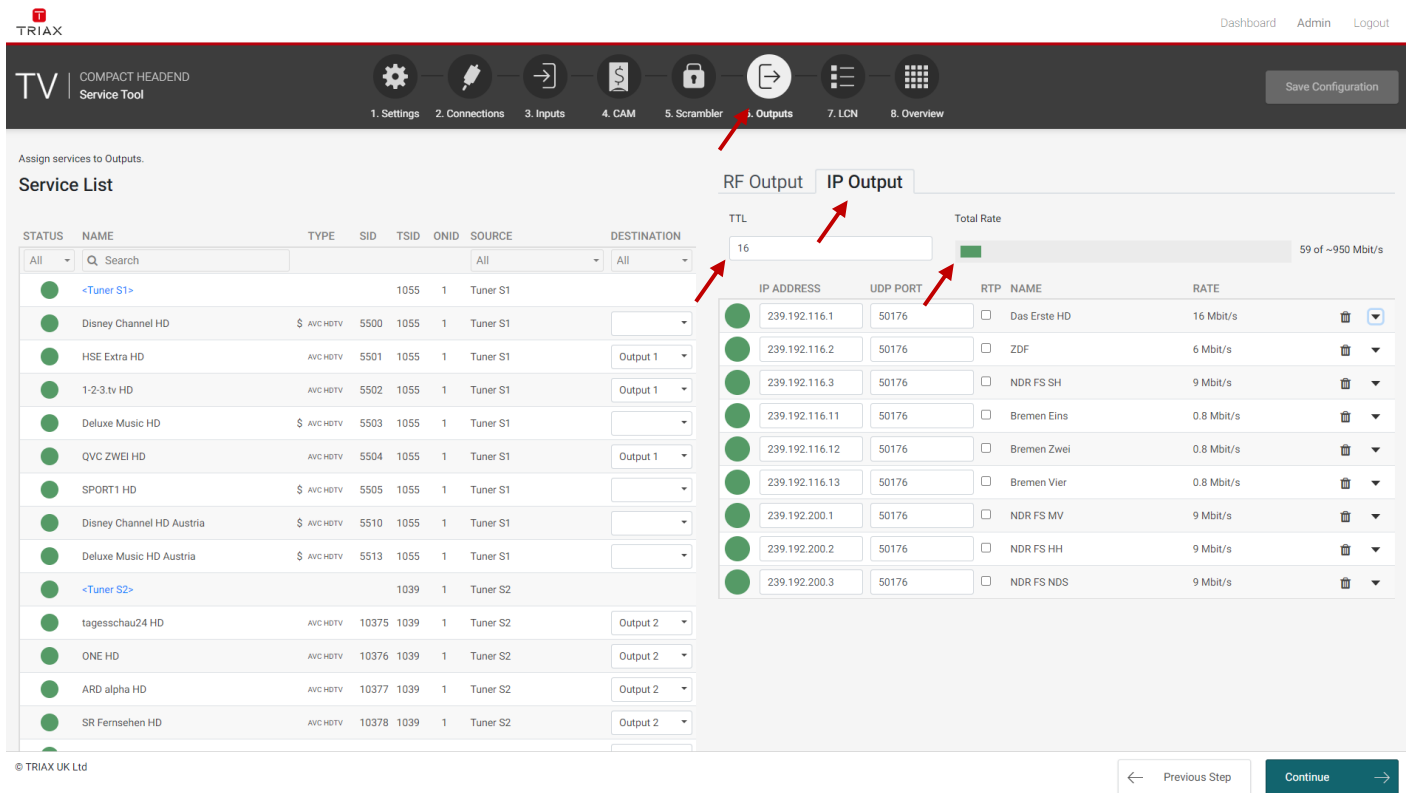

#### TTL

Time to live (TTL) or hop limit is a mechanism which limits the lifespan or lifetime of data in a computer or network. TTL may be implemented as a counter or timestamp attached to or embedded in the data. Once the prescribed event count or timespan has elapsed, data is discarded or revalidated. In computer networking, TTL prevents a data packet from circulating indefinitely. In computing applications, TTL is commonly used to improve the performance and manage the caching of data. Standard value is 16.

#### TOTAL RATE (LOAD monitor)

The payload monitor is a real time monitor, which visually indicates the amount of data that is currently being transmitted. The figure shows the total bandwidth of all IP-out services!

### Assign service to streaming at IPTV output:

Services can be assigned to an IPTV output.

Receive an IP stream by following the few steps below:

- 1) Select the *Outputs* tab in the panes.
- 2) Select the *IP Output* sub-tab.
- 3) Press the New IP output button for streaming a new IPTV out.
- 4) Specify the desired IP address and associated UDP port number.
- 5) System will automatically update the rate [Mbit/s] for the stream plus the total rate.

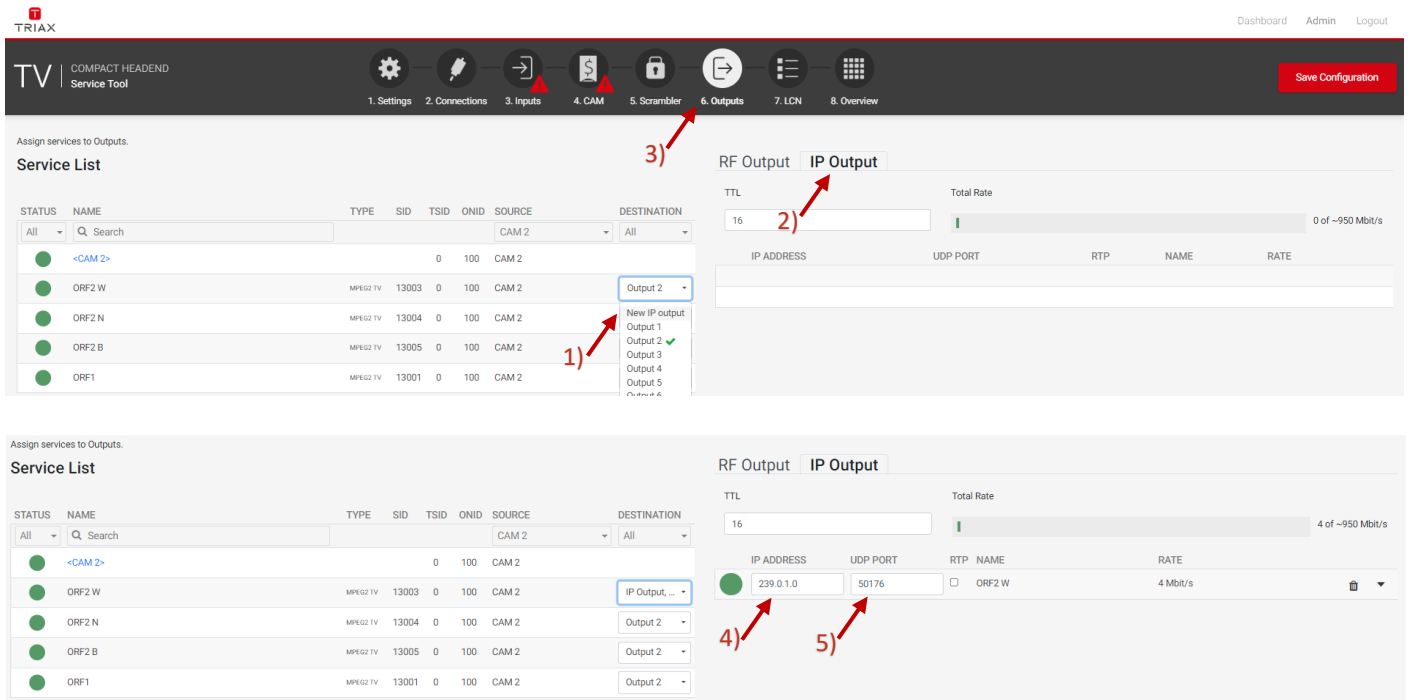

The screenshot shows the TRIAX Compact Headend Service Tool interface. The top navigation bar includes tabs for Settings, Connections, Inputs, CAM, Scrambler, Outputs, LCN, and Overview. The 'Outputs' tab is selected, and the 'IP Output' sub-tab is active. The interface is divided into two main sections: 'Service List' and 'IP Output configuration'.

**Service List:** A table with columns for STATUS, NAME, TYPE, SID, TSID, ONID, SOURCE, and DESTINATION. The table lists several services, including '<CAM 2>', 'ORF2 W', 'ORF2 N', 'ORF2 B', and 'ORF1'. The 'DESTINATION' column shows 'CAM 2' for all services. A dropdown menu for 'Output 2' is open, showing options for 'New IP output', 'Output 1', 'Output 2', 'Output 3', 'Output 4', 'Output 5', and 'Output 6'. Red arrows indicate the selection of 'Output 2' for the first service (1).

**IP Output configuration:** This section includes fields for TTL (set to 16), Total Rate (0 of ~950 Mbit/s), IP ADDRESS, and UDP PORT. A table below shows the configuration for the selected service 'ORF2 W' with an IP address of 239.0.1.0 and a UDP port of 50176. The rate is set to 4 Mbit/s. Red arrows indicate the selection of the 'IP Output' sub-tab (2), the 'New IP output' button (3), and the IP address (4) and UDP port (5) fields.

### Note:

Start the IP-out configuration by assigning the first services which should be sent out as IPTV service. Administrate the IP address. All following IPTV services will follow the IP address range by increasing the last number by 1.

### IP ADDRESS

Specifies the IP Address of an IPTV service. Enter a multicast IP address between 224.0.0.0 and 239.255.255.255 in the IP address field.

### UDP PORT

Enter the desired IP port number in the Port field within the range '1025 to '65535'.

### RTP

Select the RTP check box to enable Real-Time.

Open the detailed output configuration menu with the extend button.

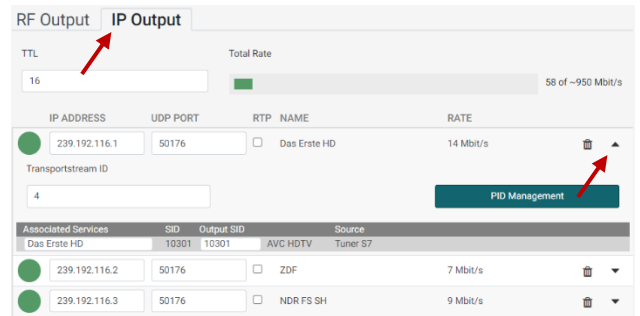

### 5.13.1 TSID and SID Management – IP Output

#### Transport stream ID

In the field Transport stream ID you will find the actual used Transport stream ID. If you would like to change this you can type a new value into the field.

*Note:*

If there is a conflict with another Transport stream using the same ID, the field and the ID number will have a red indication!

#### Output SID

In the field Output SID you will find the actual used Output SID. If you would like to change this, you can type a new value into the field.

*Note:*

If there is a conflict with another Output using the same ID, the field and the ID number will have a red indication!

### 5.13.2 Rename Service – IP Output

#### Rename Service

The service name for any service can be renamed. A service is renamed via the field below “Associated Services”.

### 5.13.3 Configure service type – IP Output

If the service has originated from a stream without SDT from an IP-input, then the service type will be unknown due to the missing SDT. The missing SDT will result in the service name being shown as “Unknown” in the *Type* field and it is possible to configure it. If in doubt then set the type to “MPEG 2 TV” for a TV service and “Radio” for a radio service.

### 5.13.4 PID Management – IP Output

Pressing the PID Management button opens the PID management menu.

In the PID Management window you will find the following information:

- Service Name
- Output SID
- Stream Type
- Details like CAS ID, Audio type, etc.
- Original PID
- Selected YES/NO
- Conflicts
- FIXED PID
- Output PID

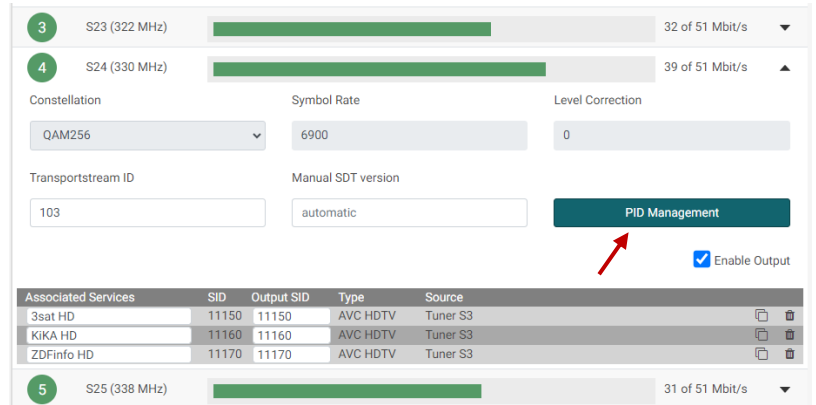

The screenshot shows a configuration window for PID Management. It includes fields for Constellation (QAM256), Symbol Rate (6900), Level Correction (0), Transportstream ID (103), and Manual SDT version (automatic). A 'PID Management' button is highlighted with a red arrow. Below the form is a table of associated services:

Associated Services	SID	Output SID	Type	Source
3sat HD	11150	11150	AVC HDTV	Tuner S3
KIKA HD	11160	11160	AVC HDTV	Tuner S3
ZDFinfo HD	11170	11170	AVC HDTV	Tuner S3

#### Filter PID's

By deselecting the filter check box you can deselect (filter) PID's.

This can be used if you would like to reduce audio or other information from the service.

#### Fixed PID

If you enter a PID in the "FIXED PID" field the PID will be changed to this setting.

#### Note:

If a PID is used twice there will be an error indication shown and the PID with the same value will be highlighted.

### 5.13.5 Multiple services – IP Output

The TDcH & TDmH support sending out IPTV services multiple times.

This functionality can be used to send out the service with different audio languages.

This has the advantage that the services are available multiple times in the service list, so the customer can choose the service with the desired audio language by simply changing the channel. They do not have to use the audio function of the television.

With this function it is also possible to make language packages in the channel plan so the services with the same languages are in one block in the channel list.

To have a service multiple time as IPTV out select the services and generate a new IP address.



## 5.14 LCN page

At the LCN page it is possible to set the Network Settings parameters and administer the LCN (Local Channel Number) numbers.

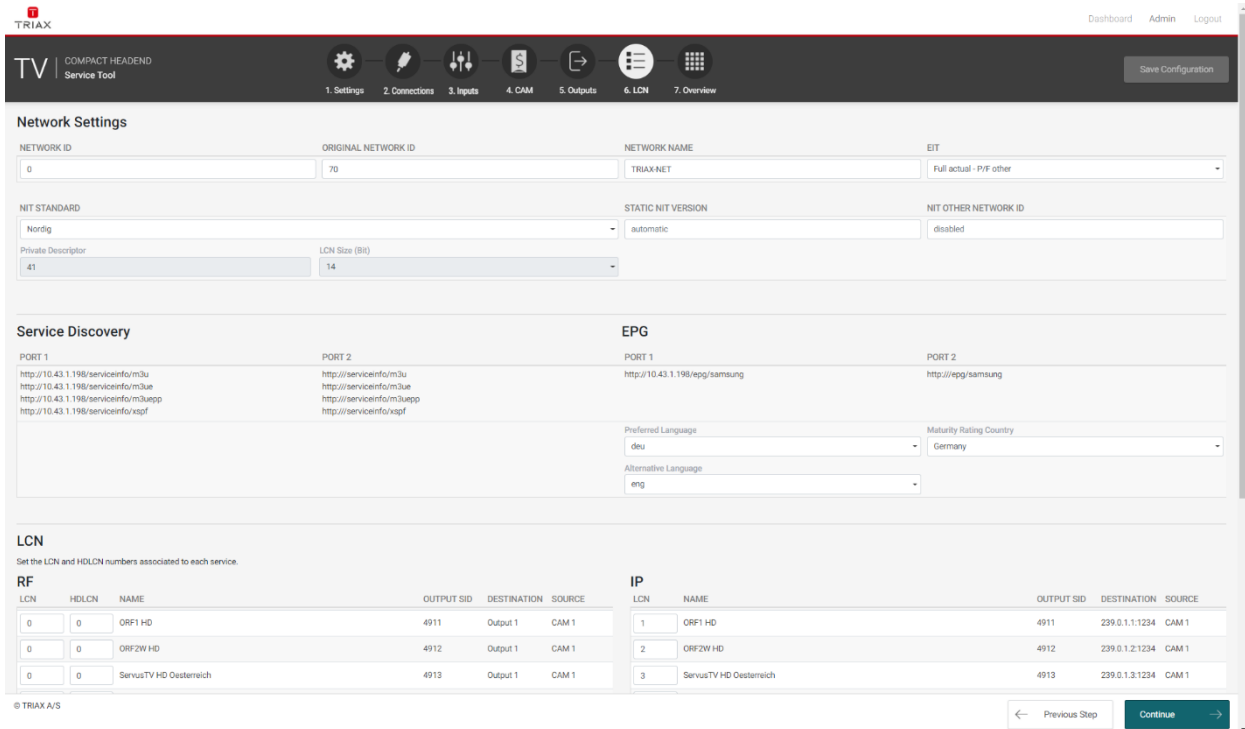

**Network Settings**

NETWORK ID: 0 ORIGINAL NETWORK ID: 70 NETWORK NAME: TRIAX-NET EIT: Full actual - P/F other

NIT STANDARD: Nordig PRIVATE DESCRIPTOR: 41 LCN Size (Bit): 14

STATIC NIT VERSION: automatic NIT OTHER NETWORK ID: disabled

**Service Discovery**

PORT 1: http://10.43.1.198/serviceinfo/m3u, http://10.43.1.198/serviceinfo/m3ue, http://10.43.1.198/serviceinfo/m3uepp, http://10.43.1.198/serviceinfo/vspf

PORT 2: http://serviceinfo/m3u, http://serviceinfo/m3ue, http://serviceinfo/m3uepp, http://serviceinfo/vspf

**EPG**

PORT 1: http://10.43.1.198/egg/samsung

PORT 2: http://egg/samsung

Preferred Language: deu Maturity Rating Country: Germany

Alternative Language: eng

**LCN**

Set the LCN and HDLCN numbers associated to each service.

LCN	HDLCN	NAME	OUTPUT SID	DESTINATION	SOURCE
0	0	ORF1 HD	4911	Output 1	CAM 1
0	0	ORF2W HD	4912	Output 1	CAM 1
0	0	ServusTV HD Oesterreich	4913	Output 1	CAM 1

LCN	NAME	OUTPUT SID	DESTINATION	SOURCE
1	ORF1 HD	4911	239.0.1.1:1234	CAM 1
2	ORF2W HD	4912	239.0.1.2:1234	CAM 1
3	ServusTV HD Oesterreich	4913	239.0.1.3:1234	CAM 1

### 5.14.1 Network Settings

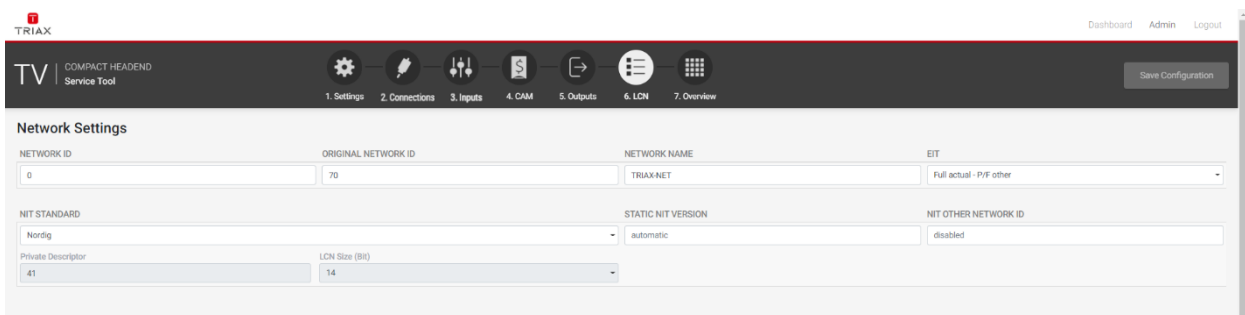

#### Network ID

Enter the required network ID in the Network ID field. If it is an open network, the network ID must follow the “ETSI TR 101 211” guidelines. If it is a closed network you can determine the ID yourself.

#### ORIGINAL NETWORK ID

Enter the required original network ID in the Original Network ID field.

#### NETWORK NAME

Enter a network name in the Network name field. The maximum number of characters you can enter in the field is 255.

**EIT (EPG Management)**

The Event Information Table (EIT) dropdown list enables you to change the EIT settings for both DVB-T and DVB-C.

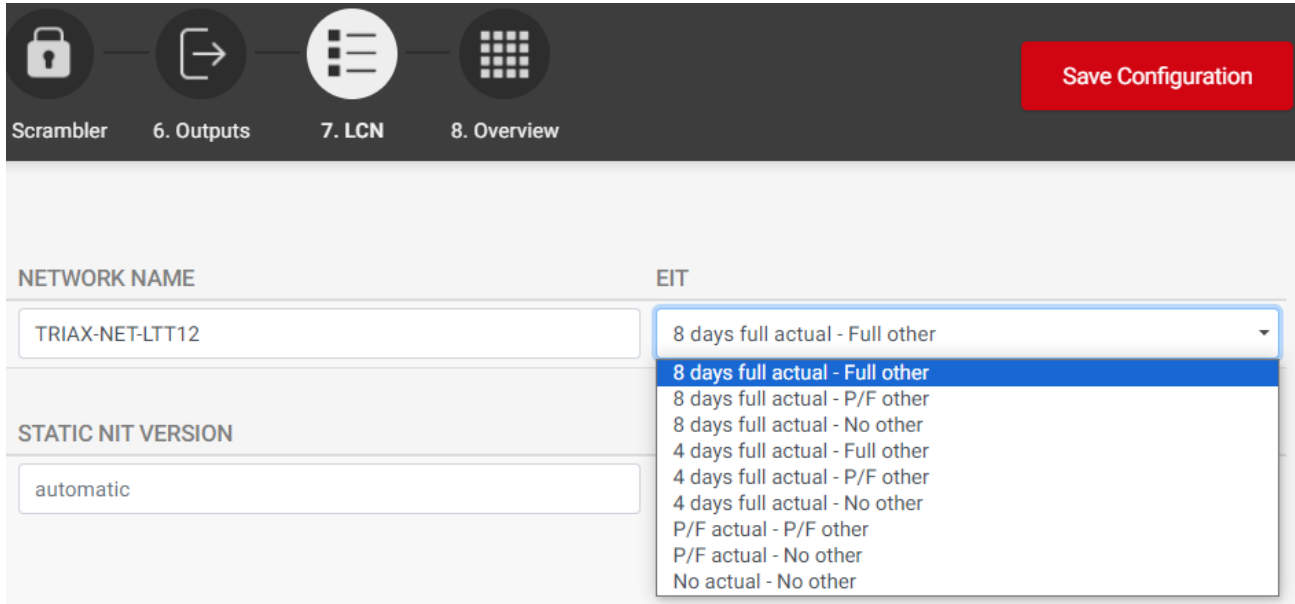
**Note:**

Please note that the TDcH & TDmH EPG management function supports 4 or 8 days EPG information per service independent of whether the EPG is set to “Full” or “P/F”. That the EPG is available at the input source is of course a general requirement.

The following settings can be set up:

- **Full Actual - Full Other (4 or 8 days)**  
All outputs will have all EIT information available, so all actual present/following, actual schedule, other present/following and other schedule EIT are sent out with all muxes.
- **Full Actual - P/F Other (4 or 8 days)**  
All outputs will have actual present/following and actual schedule EIT information, but only other present/following EIT information.
- **Full Actual - No Other (4 or 8 days)**  
All outputs will have actual present/following and actual schedule EIT information, and no other EIT information.
- **P/F Actual - P/F Other**  
All outputs will have actual present/following EIT information and other present/following EIT information only.
- **P/F Actual - No Other**  
All outputs will have actual present/following EIT information.

**No Actual - No Other**

No EIT information is output.

**NIT STANDARD**

Select which standard you want to use, DVB or NorDig. By default, DVB is selected.

**STATIC NIT VERSION (“Freeze” NIT)**

If programs in a transponder change, then the NIT is recreated. In most countries, the end user does not notice, because the receivers automatically read in the new NIT. However, in some countries (ex. France) end users are asked to start a channel search.

If it comes to the case that one or more stations have weak reception, then the NIT changes frequently and the end users are always unnecessarily prompted to start a channel search. In this case, the NIT version can be "frozen" (recommended for use in France).

Under “Static NIT version” enter a version between 1 and 31.

**Note:**

If the service list really changes, the channel search must be done manually.

**NIT OTHER NETWORK ID**

Enter the required NIT other network ID in the Network ID field.

In some countries TV’s requires a Network ID in the “NIT OTHER NETWORKD ID” field to support a network search when connected to the local CATV provider. If the headend is used for such TV’s it is also required to send the required NIT OTHER NETWORK ID in the EIT table.

### 5.14.2 Service Discovery

The TDcH & TDmH support different formats for external devices and end user devices to automatically get the actual service list.

It is possible to get the list of IP Out services in the following formats:

- XSPF
- M3U
- Extended M3U
- Extended++ M3U

Service Discovery	
PORT 1	PORT 2
http://10.43.1.198/serviceinfo/m3u	http://serviceinfo/m3u
http://10.43.1.198/serviceinfo/m3ue	http://serviceinfo/m3ue
http://10.43.1.198/serviceinfo/m3uapp	http://serviceinfo/m3uapp
http://10.43.1.198/serviceinfo/xspf	http://serviceinfo/xspf

The service lists are available at Ethernet Port 1 and 2. How to get access to the data is noted in the user interface. To validate the service list, right click at the URL and select “Go to ...” and the list will pop up at another window in your browser.

#### XSPF

Sample:

```
<?xml version="1.0" encoding="UTF-8"?>
<playlist version="1" xmlns="http://xspf.org/ns/0/">
<trackList>
<track><title>DR1</title><location>udp://@239.194.0.1:50172</location>
<extension application="http://www.com.com"><poolserviceid>4</poolserviceid></extension></track>
<track><title>Syd</title><location>udp://@239.194.0.2:50172</location>
<extension application="http://www.com.com"><poolserviceid>6</poolserviceid></extension></track>
</trackList>
</playlist>
```

#### M3U

This service list contains

- IP addresses and port numbers

Sample:

```
udp://239.194.0.1:50172
udp://239.194.0.2:50172
```

### Extended M3U

This service list is compliant to SAT>IP Protocol Specification (ver. 1.2.2) and is defined as “extended M3U channel list” In the standard under appendix A2.1

This service list contains

- IP address and port number
- Service name
- LCN

Sample:

```
#EXTM3U
#EXTINF:0,1. DR1
udp://239.194.0.1:50172
#EXTINF:0,3. Syd
udp://239.194.0.2:50172
```

### Extended++ M3U

This service list is based on the Extended M3U with further extensions.

This service list can be used for TV sets. Panasonic is one TV set vendor that supports this service list as service discovery.

This service list contains

- IP address and port number
- Service name, transport stream ID, original network ID
- LCN
- Service type (1=TV, 2=Radio)

Sample:

```
#EXTM3U
#EXTINF:0,1. DR1
udp://239.194.0.1:50172?stype=1&onid=43962&tsid=0&svcid=4
#EXTINF:0,3. Syd
udp://239.194.0.2:50172?stype=1&onid=43962&tsid=0&svcid=6
```

### 5.14.3 EPG

EPG for IPTV output can be pulled from the TDcH & TDmH.

The TDcH & TDmH have an integrated EPG server to support external devices with EPG data. This could be a middleware server or a TV management server or end user devices directly.

The service lists are available at Ethernet Port 1 and 2. How to get access to the data is noted in the user interface.

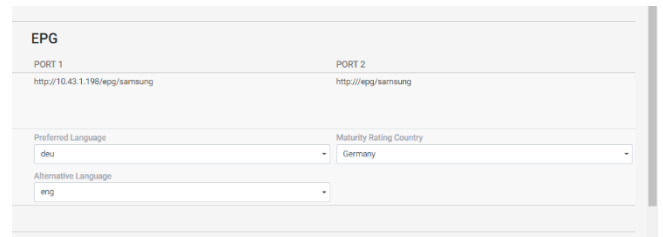

### 5.14.4 LCN

Assign LCN numbers to desired services. LCN and HD-LCN numbers in the range 0 - 1023 can be set.

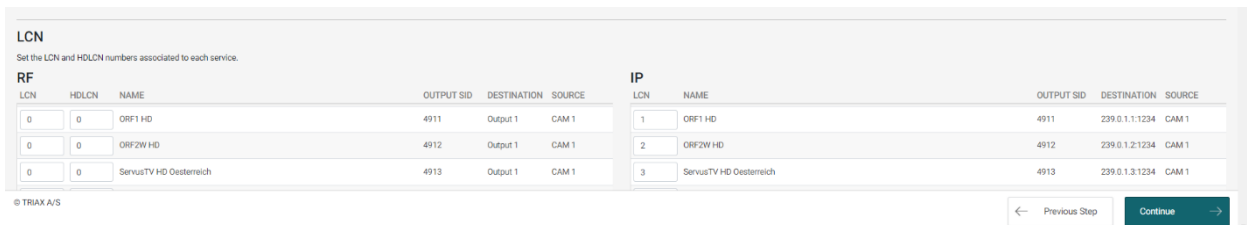

The LCN numbers can be administered for the RF outputs (QAM and COFDM) on the left side and at the right side for the IPTV services (IP Output).

When **Continue** is pressed, the next menu pane is shown.

#### LCN auto arrange

When inserting an already existing number, the number automatically increases for that number and all higher values.

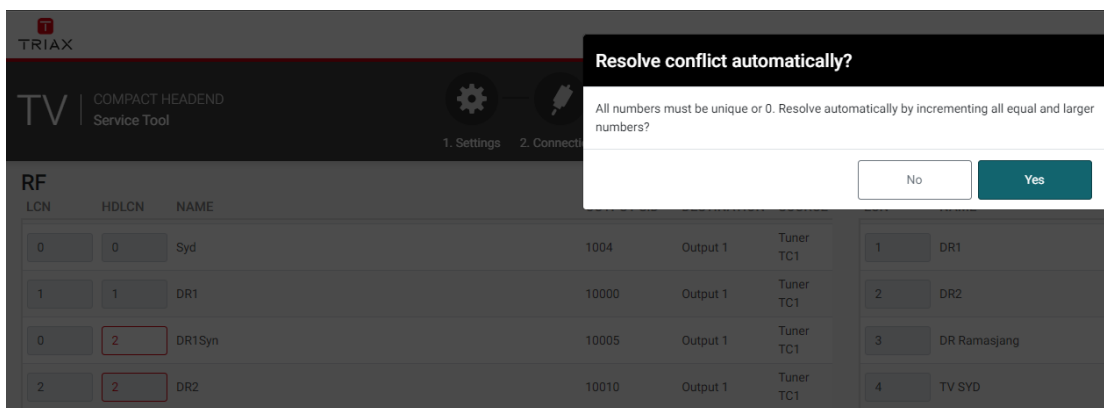

## 5.15 Overview

The overview page is a fast and easy overview with a “sort” and “search” function. By pressing the underlined links there is also the option to navigate direct to specific information and settings if needed. Please see mouse over description below.

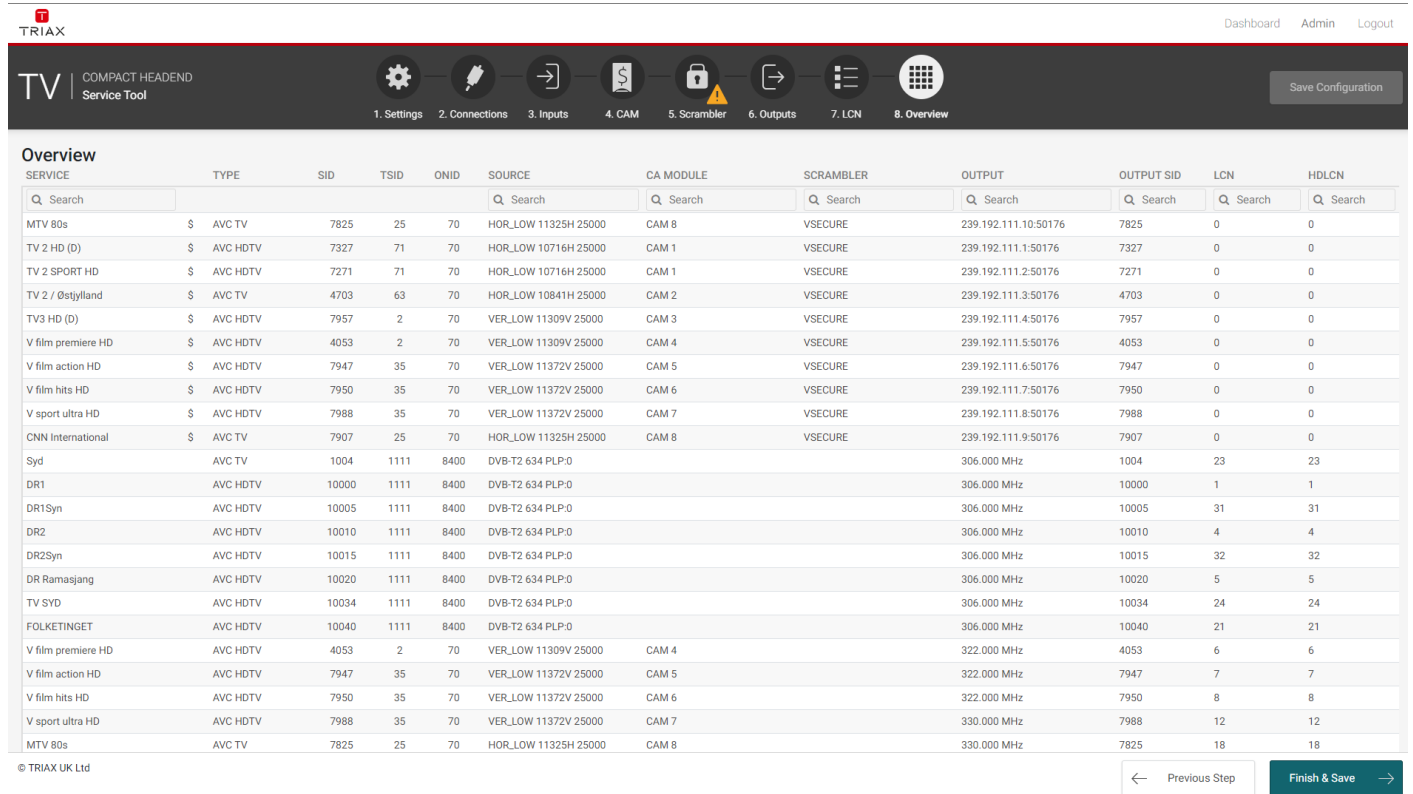

© TRIAX UK Ltd

<b>Service</b>	Name of the TV or Radio Service
<b>Type</b>	Type of the Service (HD, SD, TV, Radio, ...)
<b>SID</b>	Service identifier of the service used at the output
<b>TSID</b>	Transport stream identifier used at the output
<b>ONID</b>	Original network identifier of the service
<b>SOURCE</b>	Location from where the service is received
<b>CA MODULE</b>	The CA module used to descramble the service
<b>SCRAMBLER</b>	The Scrambler used to scramble the service
<b>OUTPUT</b>	Output channel information of a Service
<b>OUTPUT SID</b>	SID at the output
<b>LCN</b>	Local Channel number of the Services
<b>LCN HD</b>	Local Channel number of the HD Services

### Alphabetic order

With a click on the Column description, for example "SERVICE", the corresponding column will be sorted in alphabetical order. With a second click the alphabetical order is reversed.

### Search

In the Search fields it is possible to search for specific text. Start typing and the list will show only names with the characters included in the same row as in the search field.

### Mouseover

Mouseover entries can be clicked to switch to the main table of this entry.

### 5.15.1 Export to Excel

The service list for all services from the system outputs, can be accessed directly via an URL without login. The URL is <x.x.x.x/serviceinfo/overview>. This will result in a semicolon ";" separated list. If the list shall be separated by comma "," then use the URL <x.x.x.x/serviceinfo/overview?delim:comma>.

As an alternative it is easy to copy the information from the Overview page as shown below.

Step 1. Mark the information in the overview and copy the information with Ctrl+C

SERVICE	TYPE	SID	TSID	ONID	TUNER	CA MODULE	OUTPUT	OUTPUT SID	LCN	HDLCN
BR Fernsehen Süd HD	AVC HDTV	10325	31	3	DVB-C 306		306.000 MHz	10325		
NDR FS SH HD	AVC HDTV	10330	31	3	DVB-C 306		306.000 MHz	10330		
PHOENIX HD	AVC HDTV	10331	31	3	DVB-C 306		306.000 MHz	10331		
Welt der Wunder	MPEG2 TV	13103	31	3	DVB-C 306		306.000 MHz	13103		
RTLplus Austria	AVC TV	325	13	3	DVB-C 314		NaN MHz	325		
Fashion TV HD	AVC HDTV	425	13	3	DVB-C 314		NaN MHz	425		
HGTV	MPEG2 TV	426	13	3	DVB-C 314		NaN MHz	426		
TOGG0 plus	MPEG2 TV	529	13	3	DVB-C 314		NaN MHz	529		
ATV	MPEG2 TV	10120	13	3	DVB-C 314		NaN MHz	10120		
ORF2 V	MPEG2 TV	10128	13	3	DVB-C 314		NaN MHz	10128		
ORF1	MPEG2 TV	13001	13	3	DVB-C 314		NaN MHz	13001		
ProSieben Austria	MPEG2 TV	20002	13	3	DVB-C 314		NaN MHz	20002		
SAT.1 A	MPEG2 TV	20005	13	3	DVB-C 314		NaN MHz	20005		
ORF1 HD	AVC HDTV	4911	1007	1	DVB-S2 11303H 22000	CAM 1	NaN MHz	4911		

Step 2. Open a new Excel Sheet and paste the information with Ctrl+V



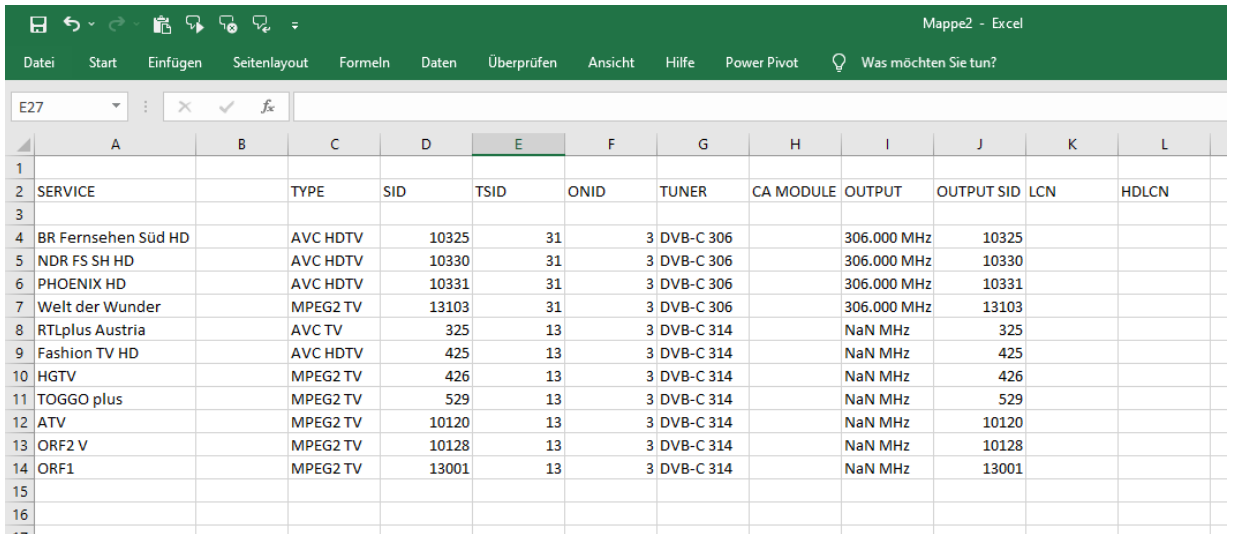

	A	B	C	D	E	F	G	H	I	J	K	L
1												
2	SERVICE		TYPE	SID	TSID	ONID	TUNER	CA MODULE	OUTPUT	OUTPUT SID	LCN	HDLCN
3												
4	BR Fernsehen Süd HD		AVC HDTV	10325	31		3 DVB-C 306		306.000 MHz	10325		
5	NDR FS SH HD		AVC HDTV	10330	31		3 DVB-C 306		306.000 MHz	10330		
6	PHOENIX HD		AVC HDTV	10331	31		3 DVB-C 306		306.000 MHz	10331		
7	Welt der Wunder		MPEG2 TV	13103	31		3 DVB-C 306		306.000 MHz	13103		
8	RTLplus Austria		AVC TV	325	13		3 DVB-C 314		NaN MHz	325		
9	Fashion TV HD		AVC HDTV	425	13		3 DVB-C 314		NaN MHz	425		
10	HGTV		MPEG2 TV	426	13		3 DVB-C 314		NaN MHz	426		
11	TOGGO plus		MPEG2 TV	529	13		3 DVB-C 314		NaN MHz	529		
12	ATV		MPEG2 TV	10120	13		3 DVB-C 314		NaN MHz	10120		
13	ORF2 V		MPEG2 TV	10128	13		3 DVB-C 314		NaN MHz	10128		
14	ORF1		MPEG2 TV	13001	13		3 DVB-C 314		NaN MHz	13001		
15												
16												
17												

**Note:**

To paste the information into Excel please use the function only Text so that no format is taken over.

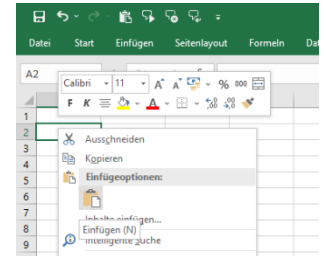

### 5.16 Direct access via URL

Following functions can be accessed directly via an URL:

URL	Function	Description
<a href="http://x.x.x.x/epg/samsung">x.x.x.x/epg/samsung</a>	EPG in Samsung XML format	Offers EPG for all IPTV out services in Samsung XML format
<a href="http://x.x.x.x/serviceinfo/m3u">x.x.x.x/serviceinfo/m3u</a>	List of IPTV out services in m3u format.	See section "Service Discovery"
<a href="http://x.x.x.x/serviceinfo/m3ue">x.x.x.x/serviceinfo/m3ue</a>	List of IPTV out services in m3u extended format.	See section "Service Discovery"
<a href="http://x.x.x.x/serviceinfo/m3uepp">x.x.x.x/serviceinfo/m3uepp</a>	List of IPTV out services in m3u extended++ format.	See section "Service Discovery"
<a href="http://x.x.x.x/serviceinfo/overview">x.x.x.x/serviceinfo/overview</a>	List all services output at the system in CVS format with semicolon as separator.	See section "Export to Excel"
<a href="http://x.x.x.x/serviceinfo/overview?delim:comma">x.x.x.x/serviceinfo/overview?delim:comma</a>	List all services output at the system in CVS format with colon as separator.	See section "Export to Excel"

### 5.17 Direct file download via URL

Following files can be downloaded directly to browser “Default Download” via an URL:

URL	File	Description
x.x.x.x/logfile	tdch_logfile.zip	Zipped log files
x.x.x.x/mib	TRIAX-TDCH_MIB.txt	MIB file as txt file. Some SNMP managers support importing in other file formats like *.mib. If your SNMP manager doesn't support the txt file, then rename it to e.g. *.mib.

## 6 Support

Contact your local sales representative for support information in your language, or alternatively

Go to [www.triax.com](http://www.triax.com).

for English support.

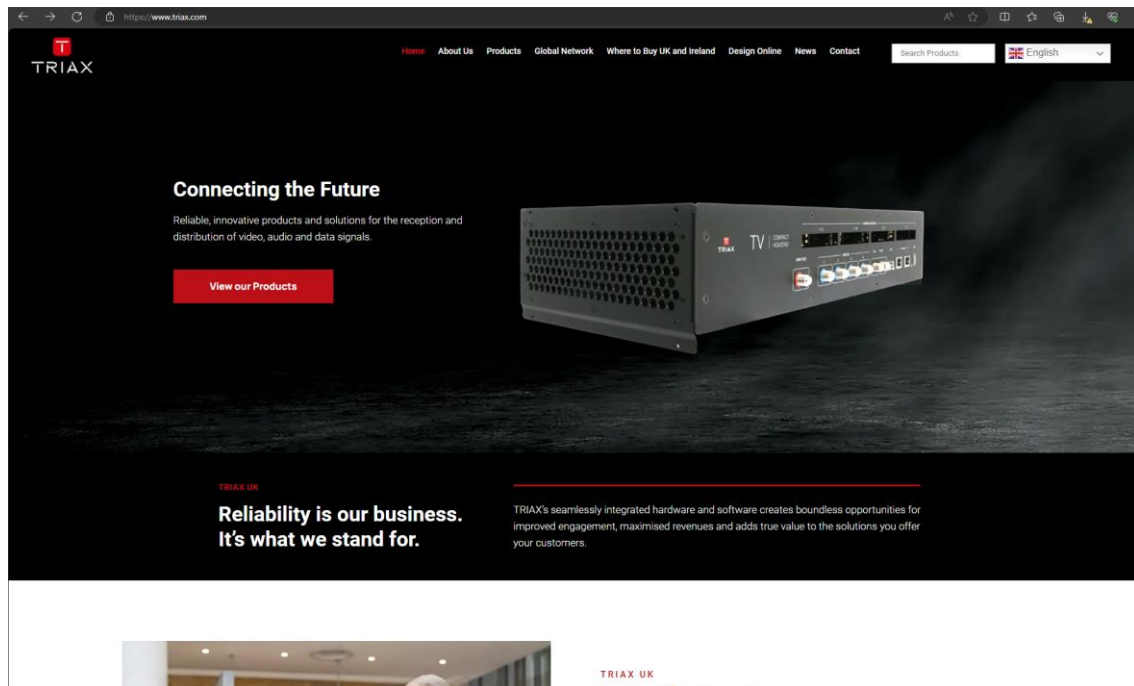

Below the *Contact* menu you will find additional help and support information.



## 7 Terms and Abbreviations

Term	Explanation
TBA	To Be Added
TBD	To Be Determined
PID	Packet Identification; According to standard ISO 13818-1
SID	Service Identification; According to standard ISO 13818-1
TSID	Transport Stream Identification
NIT	Network Identification Table; According to standard ETSI EN 300 468
NID	Network Identification used in NIT; According to standard ETSI EN 300 468
ONID	Original Network Identification used in NIT; According to standard ETSI EN 300 468
STB	Set Top Box; DVB/IP receiver that is connected to a TV set
Receiver	A device that receives a signal from a headend. An example could be a TV-set or a STB.
end-user	A person that uses a TV or receiver.
Installer	A person that installs, deploys, and maintains the headend system
i/f	Interface
TS	Transport Stream; According to standard ISO 13818-1
ES	Elementary Stream; According to standard ISO 13818-1
Service	According to ETSI EN 300 468